

ROECO

Bearing Data

Ball Bearing Units

Bearing No. : **UK207+H2307**

Dimensions

d1 = 30

d2 = 52

dT1 = 38

B1 = 43

B2 = 9

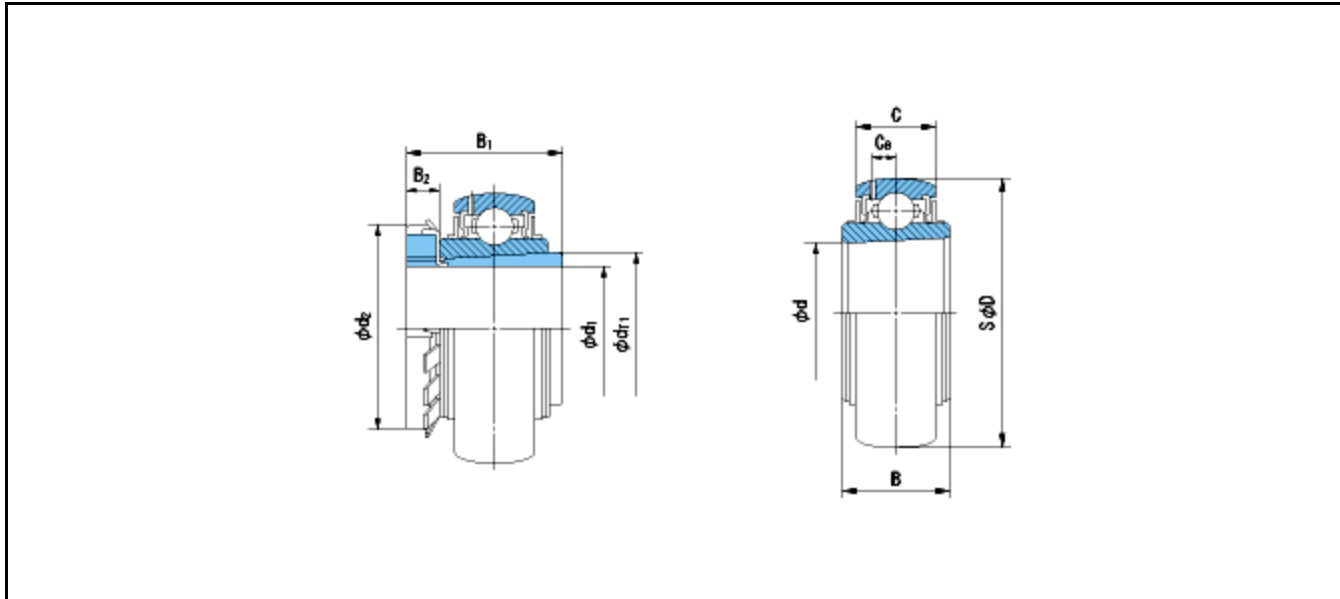

Dimensions

D = 72

d = 35

B = 27

C = 20

Ca = 5.8

Mass = 0.53 kg

Basic Dynamic Load Rating Cr :	25900 N				
Basic Static Load Rating Cor :	15400 N	O.D.Surface Runout with Side :			-
Limiting Speed ;		Axial Runout with Bore :			-
Grease Lubrication :	- rpm	Axial Runout with Raceway :			-
Oil Lubrication :	- rpm	Width Variation :			-
		Radial Runout :			-