

ROECO

Bearing Data

Ball Bearing Units

Bearing No. : **UCTX11**

Dimensions

- H = 146
- H2 = 102
- L = 194
- L1 = 119
- L2 = 19
- L3 = 102
- N = 35
- N1 = 32
- N2 = 64

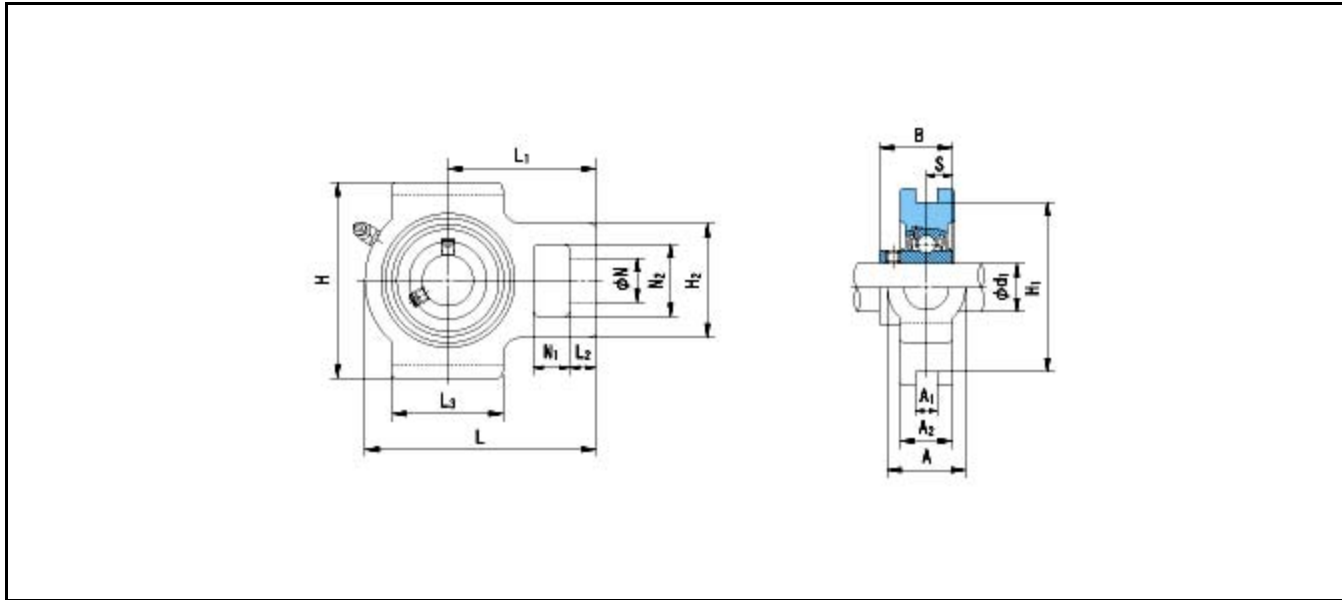

Dimensions

- d1 = 55
- A1 = 22
- A2 = 44
- A = 64
- H1 = 130
- B = 65.1
- S = 25.4
- Mass = 5.2 kg

Basic Dynamic Load Rating Cr :	52500 N		
Basic Static Load Rating Cor :	36100 N	O.D.Surface Runout with Side :	-
Limiting Speed ;		Axial Runout with Bore :	-
Grease Lubrication :	- rpm	Axial Runout with Raceway :	-
Oil Lubrication :	- rpm	Width Variation :	-
		Radial Runout :	-

INNER RING OUTER RING