

ROECO

Bearing Data

Ball Bearing Units

Bearing No. : **UCTX05**

Dimensions

H = 102

H2 = 56

L = 113

L1 = 70

L2 = 10

L3 = 57

N = 22

N1 = 16

N2 = 37

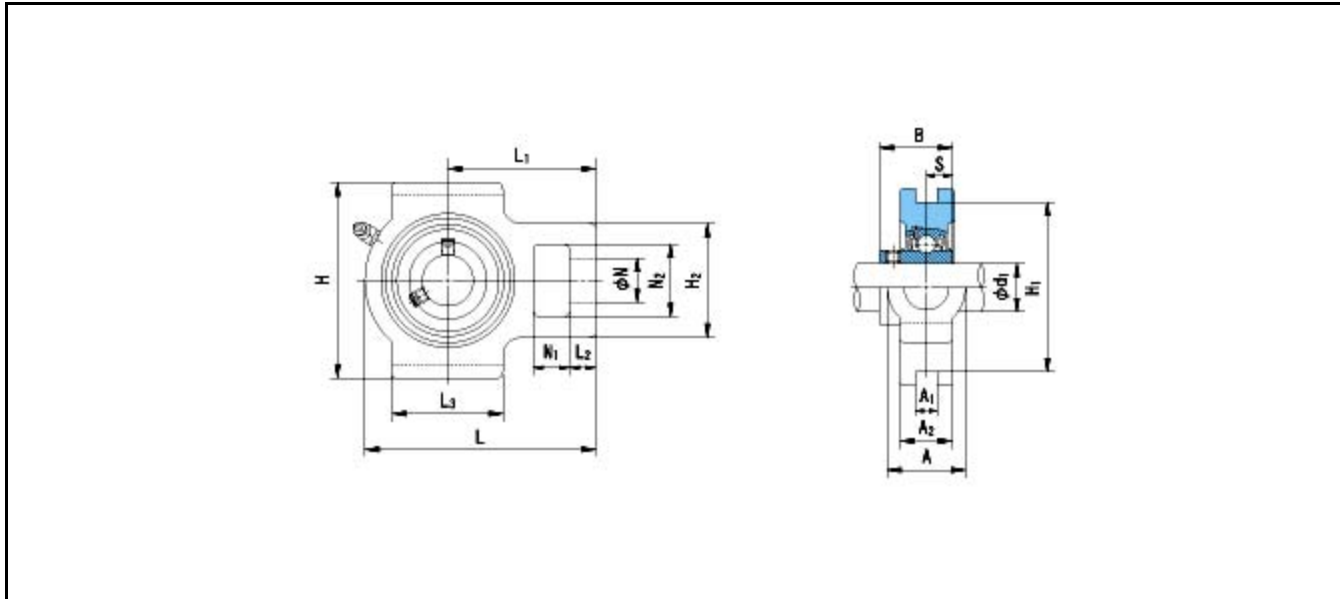

Dimensions

d1 = 25

A1 = 12

A2 = 28

A = 37

H1 = 89

B = 38.1

S = 15.9

Mass = 1.3 kg

Basic Dynamic Load Rating Cr :	19600 N	INNER RING	OUTER RING
Basic Static Load Rating Cor :	11300 N	O.D.Surface Runout with Side :	-
Limiting Speed ;		Axial Runout with Bore :	-
Grease Lubrication :	- rpm	Axial Runout with Raceway :	-
Oil Lubrication :	- rpm	Width Variation :	-
		Radial Runout :	-