

ROECO

Bearing Data

Ball Bearing Units

Bearing No. : **UCT213+WB**

Dimensions

- H = 322
- L = 606
- J = 260
- J1 = 260
- N = 15
- L1 = 22
- L2 = 144
- L3 = 300
- G2 = Tr36
- L0 = 699

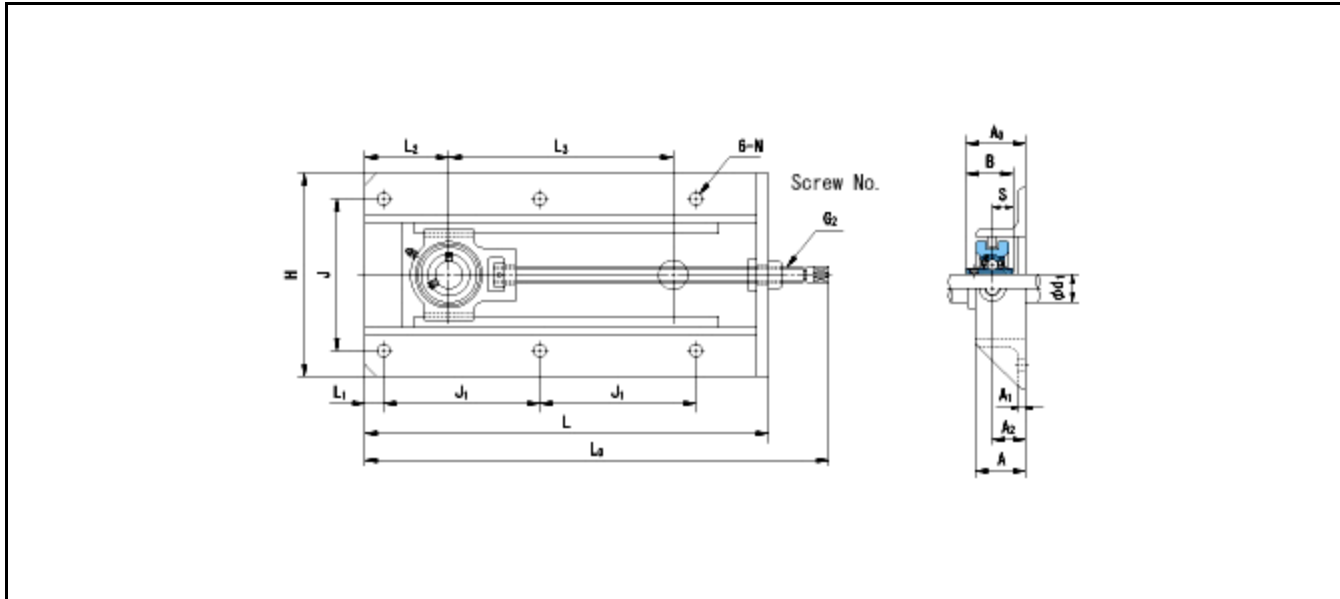

Dimensions

- d1 = 65
- A1 = 38
- A2 = 6
- A = 65
- A0 = 77.7
- S = 25.4
- Mass = 23.4 kg

Basic Dynamic Load Rating Cr :	57500 N	INNER RING	OUTER RING
Basic Static Load Rating Cor :	40000 N	O.D.Surface Runout with Side :	-
Limiting Speed ;		Axial Runout with Bore :	-
Grease Lubrication :	- rpm	Axial Runout with Raceway :	-
Oil Lubrication :	- rpm	Width Variation :	-
		Radial Runout :	-