

ROECO

Bearing Data

Ball Bearing Units

Bearing No. : **UCT209**

Dimensions

H = 117

H2 = 83

L = 144

L1 = 87

L2 = 16

L3 = 83

N = 29

N1 = 19

N2 = 49

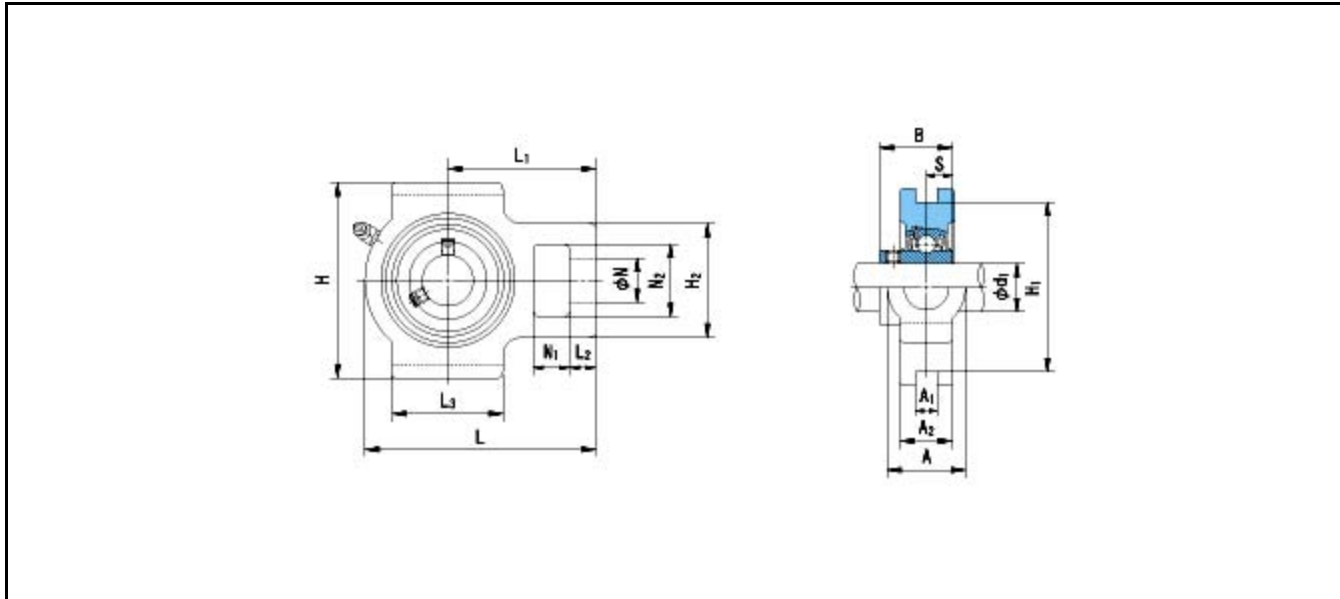

Dimensions

d1 = 45

A1 = 16

A2 = 35

A = 49

H1 = 102

B = 49.2

S = 19

Mass = 2.4 kg

Basic Dynamic Load Rating Cr :	33000 N	INNER RING	OUTER RING
Basic Static Load Rating Cor :	20500 N	O.D.Surface Runout with Side :	-
Limiting Speed ;		Axial Runout with Bore :	-
Grease Lubrication :	- rpm	Axial Runout with Raceway :	-
Oil Lubrication :	- rpm	Width Variation :	-
		Radial Runout :	-