

ROECO

Bearing Data

Ball Bearing Units

Bearing No. : **UCT207**

Dimensions

H = 102

H2 = 64

L = 129

L1 = 78

L2 = 13

L3 = 64

N = 22

N1 = 16

N2 = 37

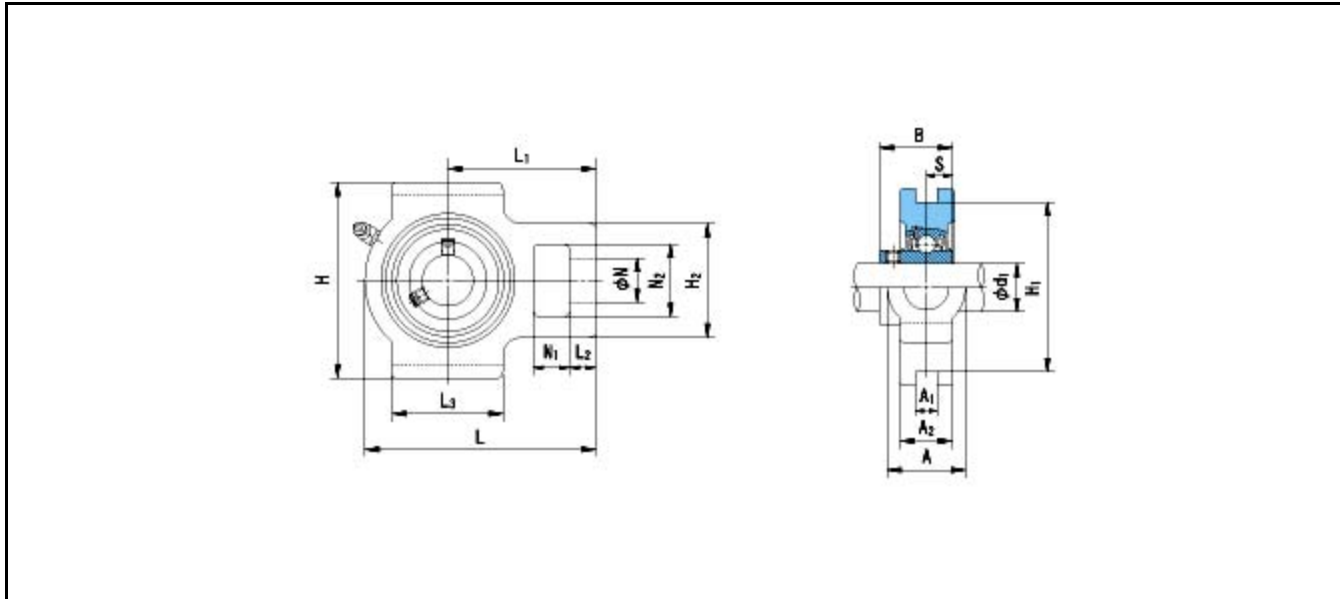

Dimensions

d1 = 35

A1 = 12

A2 = 30

A = 37

H1 = 89

B = 42.9

S = 17.5

Mass = 1.6 kg

Basic Dynamic Load Rating Cr :	25900 N		INNER RING	OUTER RING
Basic Static Load Rating Cor :	15400 N	O.D.Surface Runout with Side :		-
Limiting Speed ;		Axial Runout with Bore :	-	-
Grease Lubrication :	- rpm	Axial Runout with Raceway :	-	-
Oil Lubrication :	- rpm	Width Variation :	-	-
		Radial Runout :	-	-