

ROECO

Bearing Data

Ball Bearing Units

Bearing No. : **UCT207+WB**

Dimensions

- H = 212
- L = 429
- J = 166
- J1 = 173
- N = 12
- L1 = 19
- L2 = 99
- L3 = 230
- G2 = Tr18
- L0 = 490

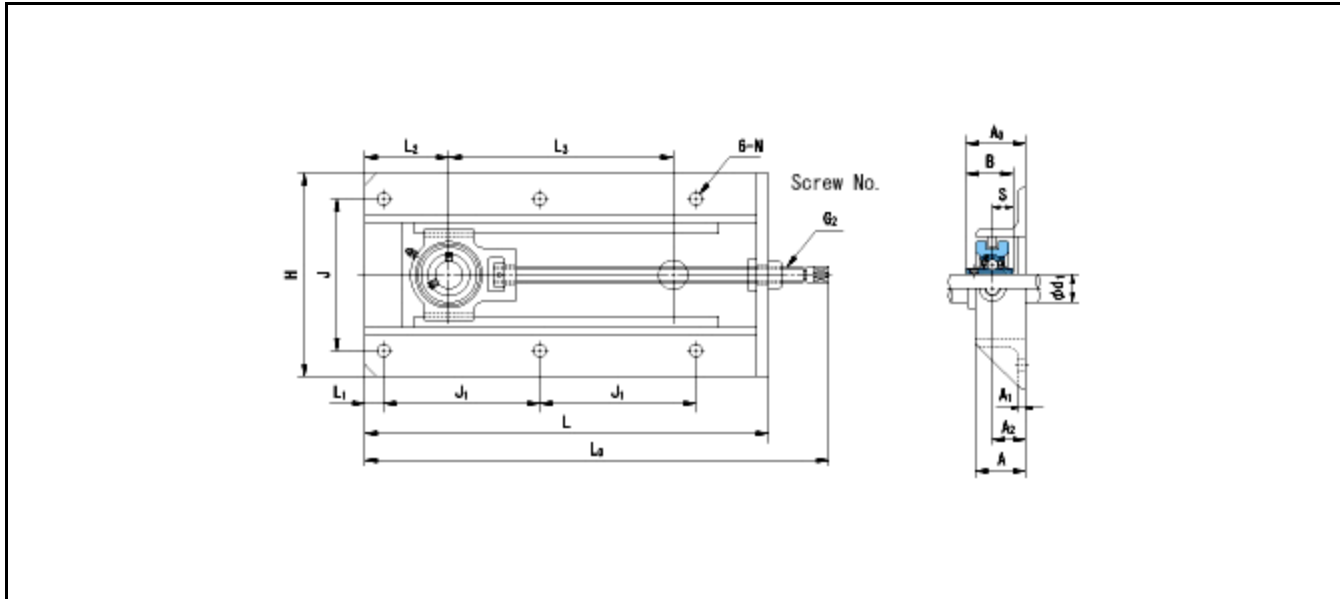

Dimensions

- d1 = 35
- A1 = 30
- A2 = 6
- A = 50
- A0 = 55.4
- S = 17.5
- Mass = 7.9 kg

Basic Dynamic Load Rating Cr :	25900 N	INNER RING	OUTER RING
Basic Static Load Rating Cor :	15400 N	O.D.Surface Runout with Side :	-
Limiting Speed ;		Axial Runout with Bore :	-
Grease Lubrication :	- rpm	Axial Runout with Raceway :	-
Oil Lubrication :	- rpm	Width Variation :	-
		Radial Runout :	-