

ROECO

Bearing Data

Ball Bearing Units

Bearing No. : **UCT204**

Dimensions

- H = 89
- H2 = 51
- L = 94
- L1 = 61
- L2 = 10
- L3 = 51
- N = 19
- N1 = 16
- N2 = 32

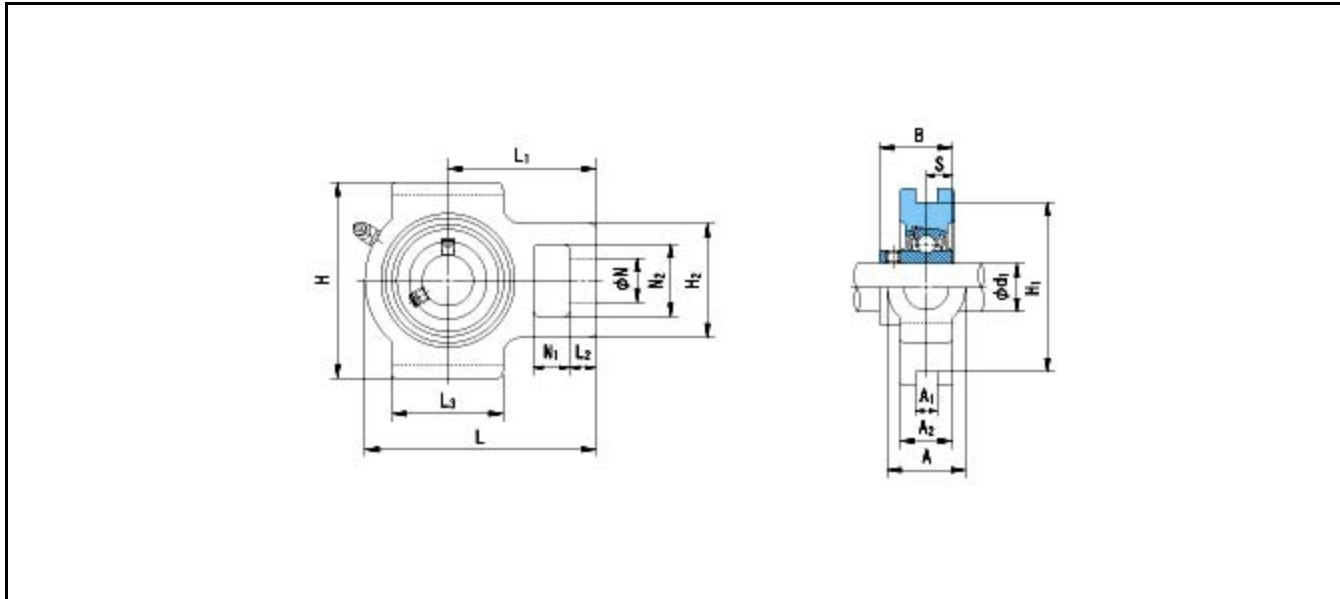

Dimensions

- d1 = 20
- A1 = 12
- A2 = 21
- A = 32
- H1 = 76
- B = 31
- S = 12.7
- Mass = 0.74 kg

Basic Dynamic Load Rating Cr :	12800 N	INNER RING	OUTER RING
Basic Static Load Rating Cor :	6600 N	O.D.Surface Runout with Side :	-
Limiting Speed ;		Axial Runout with Bore :	-
Grease Lubrication :	- rpm	Axial Runout with Raceway :	-
Oil Lubrication :	- rpm	Width Variation :	-
		Radial Runout :	-