

ROECO

Bearing Data

Ball Bearing Units

Bearing No. : **UCPX15**

Dimensions

H = 88.9
L = 330
J = 229
N1 = 51
H1 = 35
H2 = 177

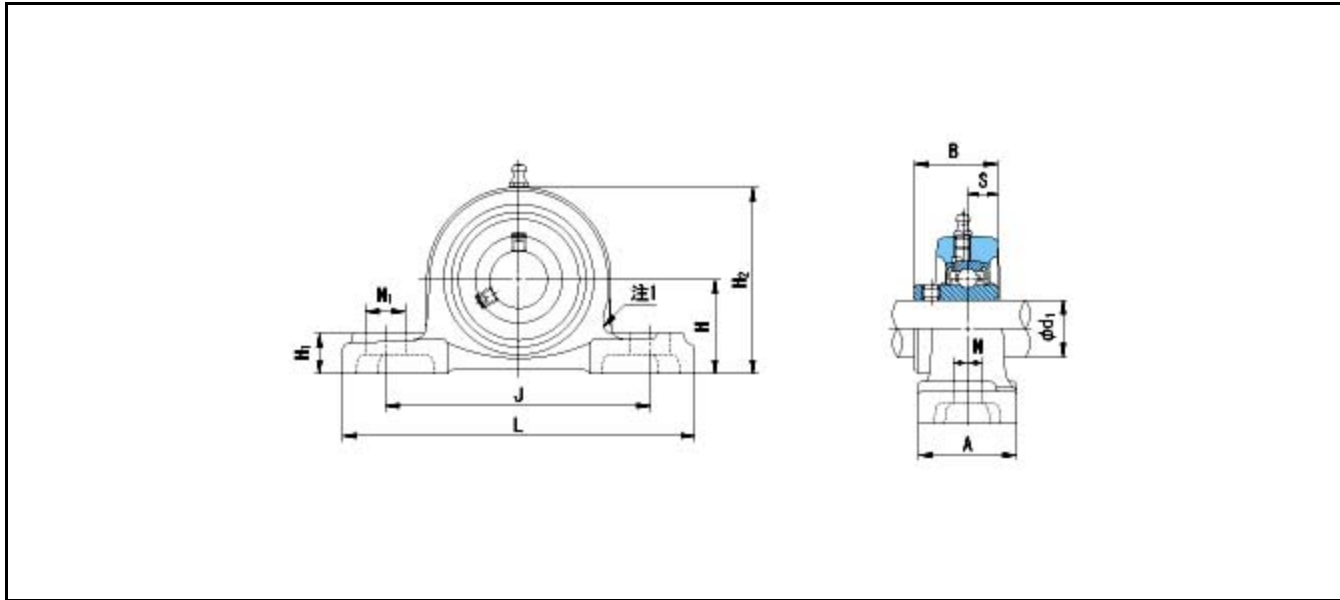

Dimensions

d1 = 75
A = 89
N = 27
B = 82.6
S = 33.3
Mass = 11.4 kg

Basic Dynamic Load Rating Cr :	72500 N	INNER RING	OUTER RING
Basic Static Load Rating Cor :	53000 N	O.D.Surface Runout with Side :	-
Limiting Speed ;		Axial Runout with Bore :	-
Grease Lubrication :	- rpm	Axial Runout with Raceway :	-
Oil Lubrication :	- rpm	Width Variation :	-
		Radial Runout :	-