

ROECO

Bearing Data

Ball Bearing Units

Bearing No. : **UCPA209**

Dimensions

- H = 54.2
- L = 120
- J = 90
- G1 = M14*2
- H1 = 12
- H2 = 108

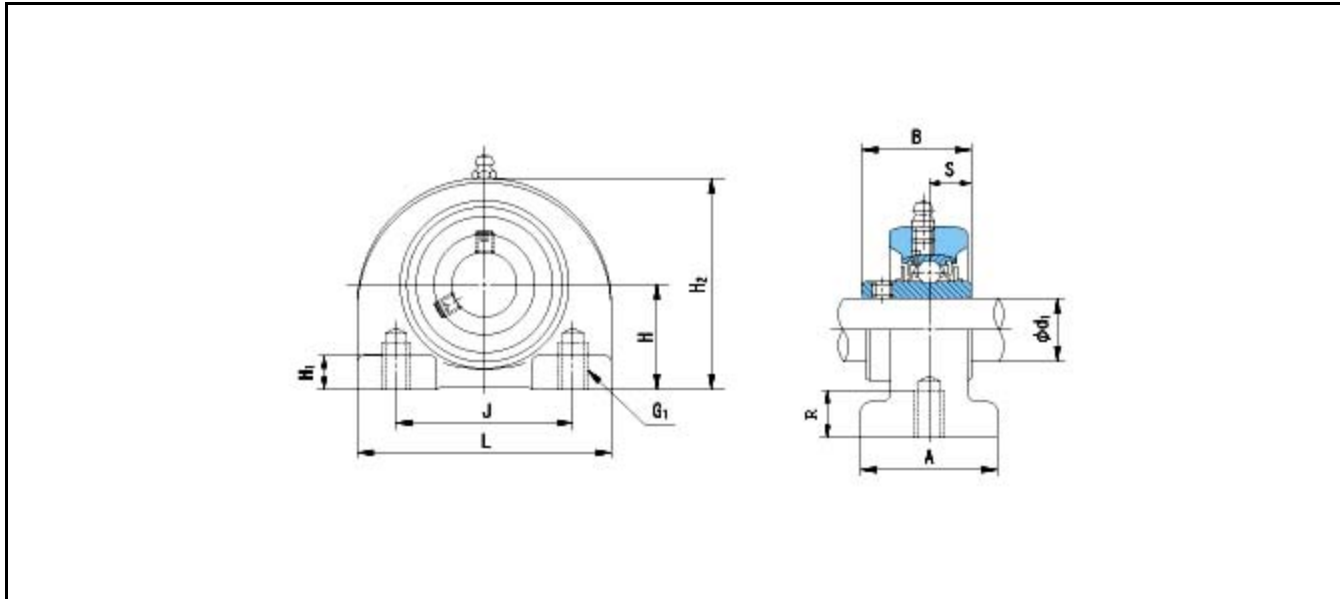

Dimensions

- d1 = 45
- A = 54
- B = 49.2
- S = 19
- I = 120
- Mass = 2.11 kg

Basic Dynamic Load Rating Cr :	33000 N	INNER RING	OUTER RING
Basic Static Load Rating Cor :	20500 N	O.D.Surface Runout with Side :	-
Limiting Speed ;		Axial Runout with Bore :	-
Grease Lubrication :	- rpm	Axial Runout with Raceway :	-
Oil Lubrication :	- rpm	Width Variation :	-
		Radial Runout :	-