

ROECO

Bearing Data

Ball Bearing Units

Bearing No. : **UCPA204**

Dimensions

- H = 30.2
- L = 76
- J = 52
- G1 = M10*1.5
- H1 = 8
- H2 = 62

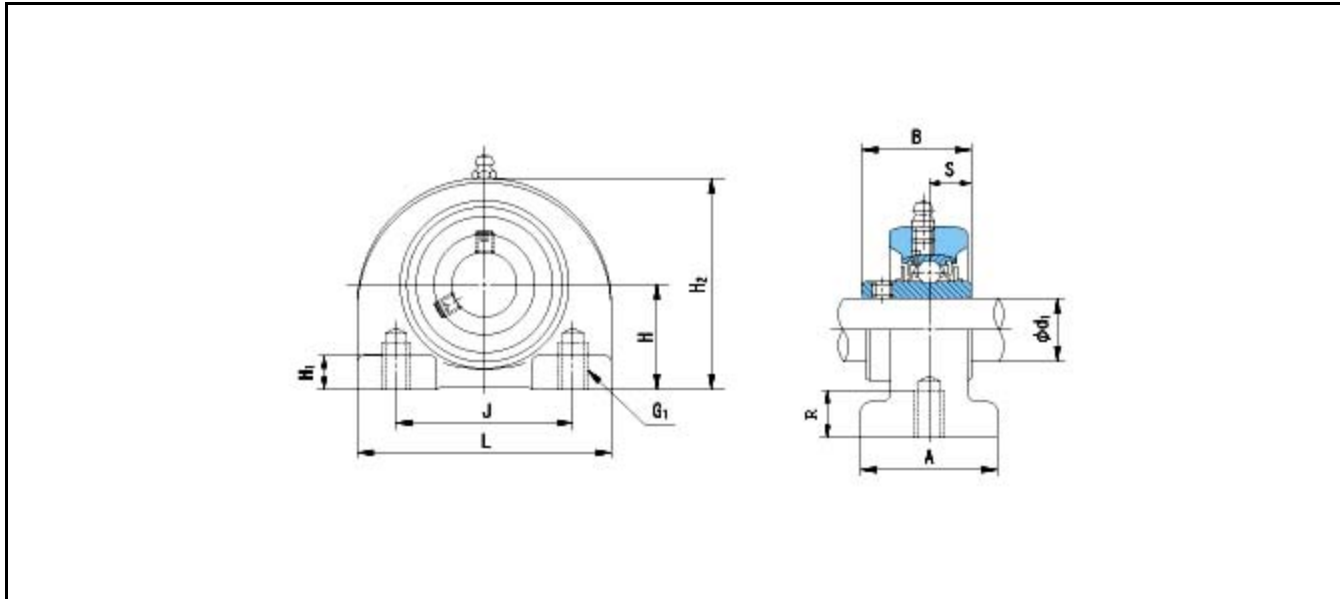

Dimensions

- d1 = 20
- A = 38
- B = 31
- S = 12.7
- I = 76
- Mass = 0.54 kg

Basic Dynamic Load Rating Cr :	12800 N	INNER RING	OUTER RING
Basic Static Load Rating Cor :	6600 N	O.D.Surface Runout with Side :	-
Limiting Speed ;		Axial Runout with Bore :	-
Grease Lubrication :	- rpm	Axial Runout with Raceway :	-
Oil Lubrication :	- rpm	Width Variation :	-
		Radial Runout :	-