

ROECO

Bearing Data

Ball Bearing Units

Bearing No. : **UCP328**

Dimensions

H = 200

L = 620

J = 500

N1 = 55

H1 = 80

H2 = 388

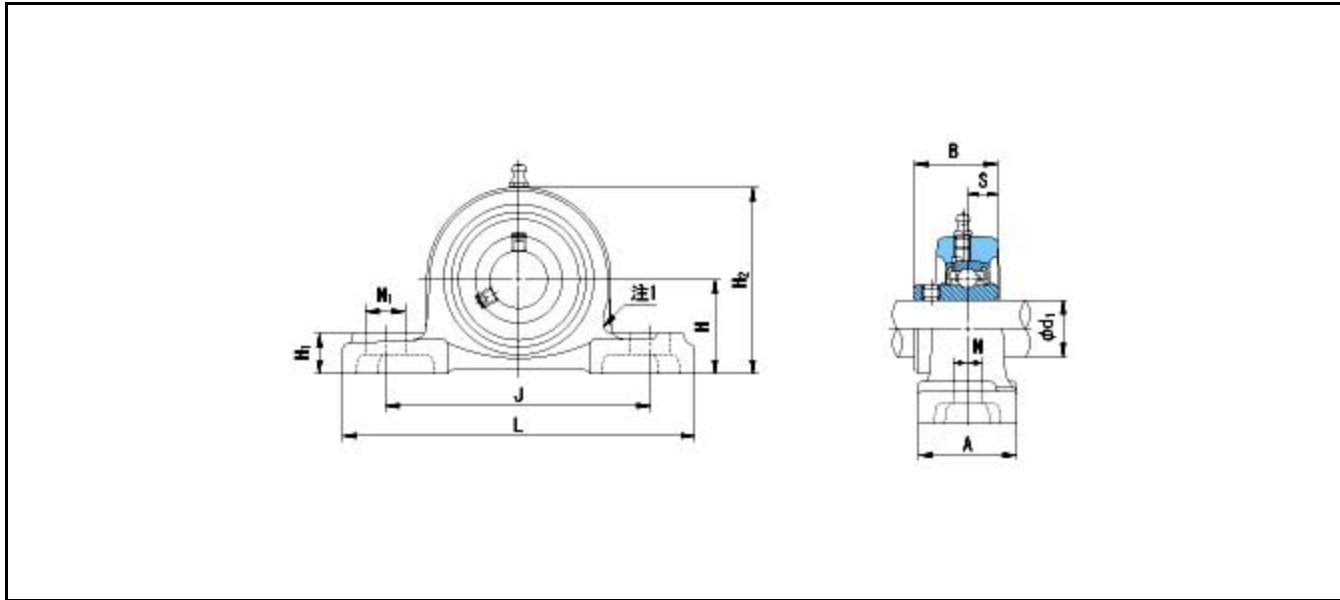

Dimensions

d1 = 140

A = 140

N = 40

B = 145

S = 59

Mass = 89.1 kg

Basic Dynamic Load Rating Cr :	255000 N			
Basic Static Load Rating Cor :	246000 N	O.D.Surface Runout with Side :		-
Limiting Speed ;		Axial Runout with Bore :		-
Grease Lubrication :	- rpm	Axial Runout with Raceway :		-
Oil Lubrication :	- rpm	Width Variation :		-
		Radial Runout :		-