

ROECO

Bearing Data

Ball Bearing Units

Bearing No. : **UCP322**

Dimensions

H = 150

L = 520

J = 400

N1 = 55

H1 = 60

H2 = 295

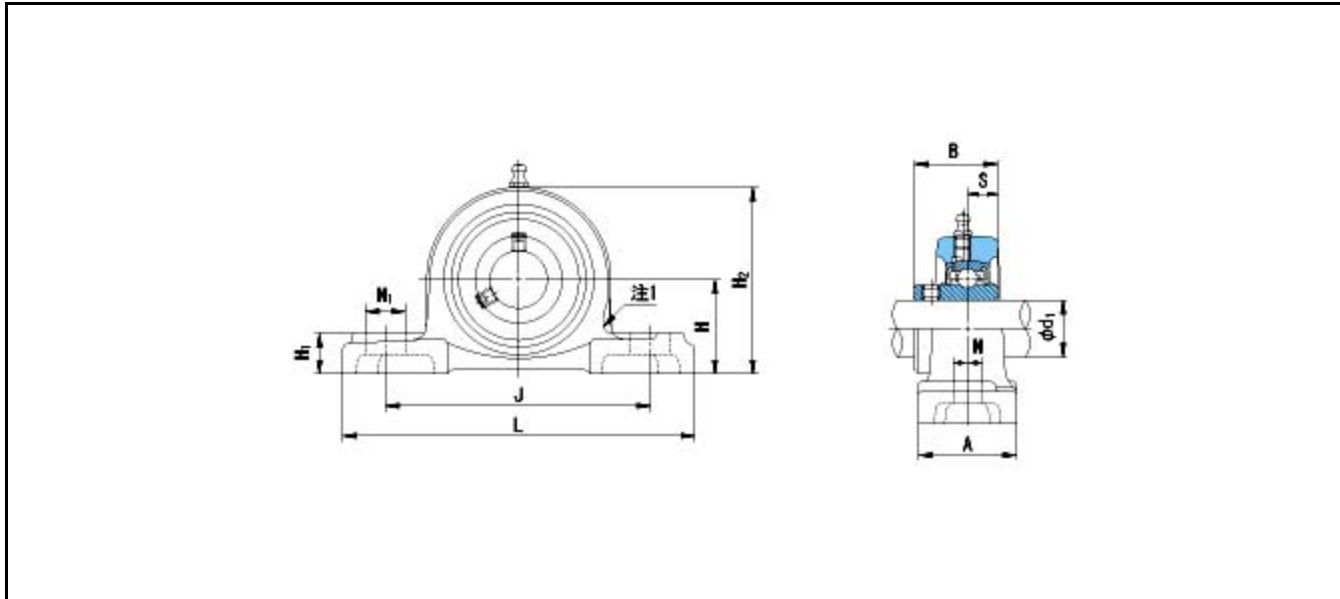

Dimensions

d1 = 110

A = 140

N = 40

B = 117

S = 46

Mass = 42.5 kg

Basic Dynamic Load Rating Cr :	205000 N			
Basic Static Load Rating Cor :	178800 N	O.D.Surface Runout with Side :		-
Limiting Speed ;		Axial Runout with Bore :		-
Grease Lubrication :	- rpm	Axial Runout with Raceway :		-
Oil Lubrication :	- rpm	Width Variation :		-
		Radial Runout :		-