

ROECO

Bearing Data

Ball Bearing Units

Bearing No. : **UCP320**

Dimensions

H = 140

L = 490

J = 380

N1 = 50

H1 = 55

H2 = 275

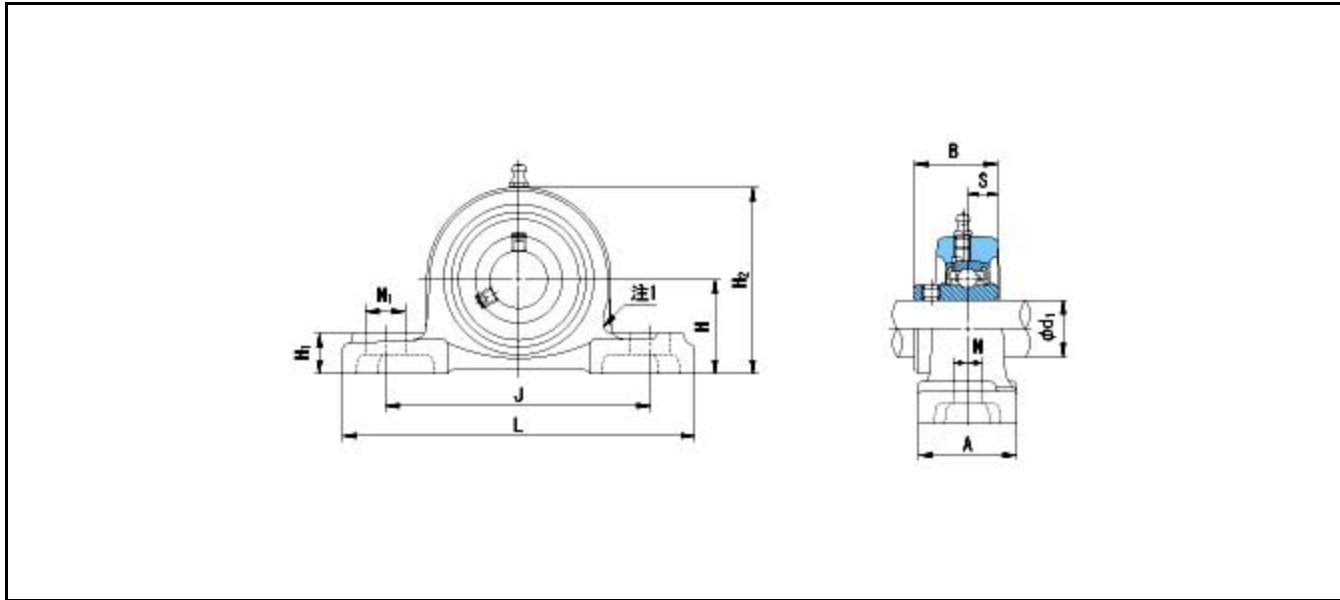

Dimensions

d1 = 100

A = 120

N = 36

B = 108

S = 42

Mass = 34.3 kg

Basic Dynamic Load Rating Cr :	173000 N		
Basic Static Load Rating Cor :	140400 N	O.D.Surface Runout with Side :	-
Limiting Speed ;		Axial Runout with Bore :	-
Grease Lubrication :	- rpm	Axial Runout with Raceway :	-
Oil Lubrication :	- rpm	Width Variation :	-
		Radial Runout :	-