

ROECO

Bearing Data

Ball Bearing Units

Bearing No. : **UCP318**

Dimensions

H = 118

L = 430

J = 330

N1 = 45

H1 = 50

H2 = 233

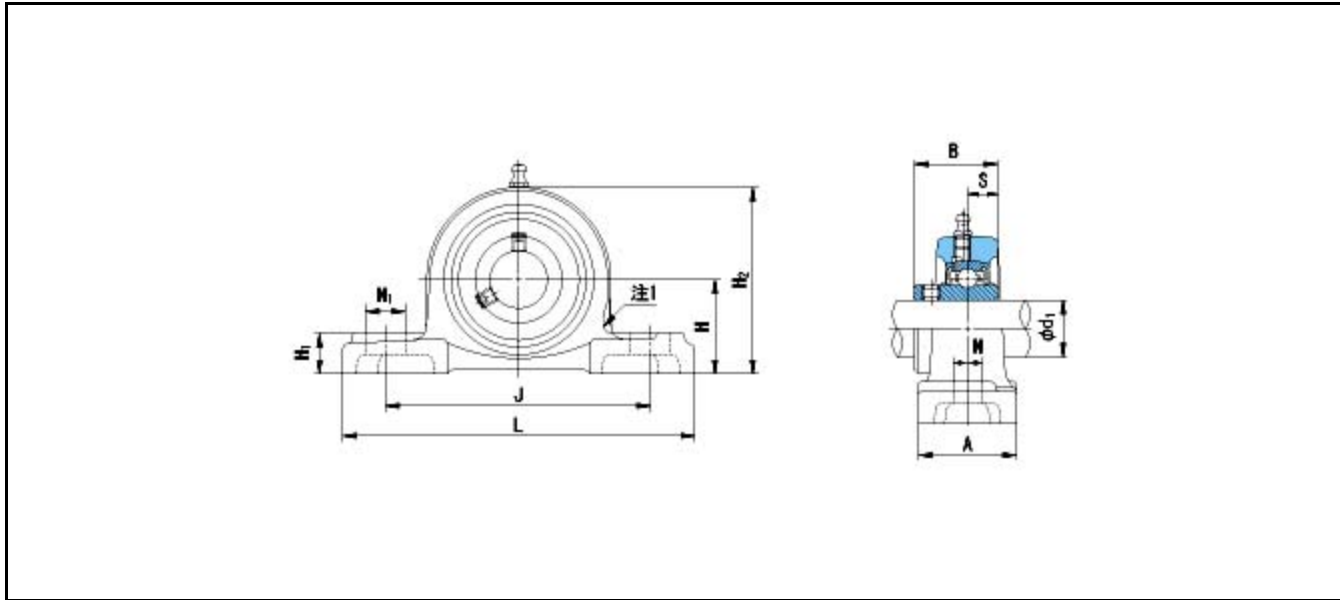

Dimensions

d1 = 90

A = 110

N = 33

B = 96

S = 40

Mass = 20.9 kg

Basic Dynamic Load Rating Cr :	143000 N		
Basic Static Load Rating Cor :	107200 N	O.D.Surface Runout with Side :	-
Limiting Speed ;		Axial Runout with Bore :	-
Grease Lubrication :	- rpm	Axial Runout with Raceway :	-
Oil Lubrication :	- rpm	Width Variation :	-
		Radial Runout :	-