

ROECO

# Bearing Data

## Ball Bearing Units

Bearing No. : **UCP317**

Dimensions

H = 112

L = 420

J = 320

N1 = 45

H1 = 45

H2 = 221

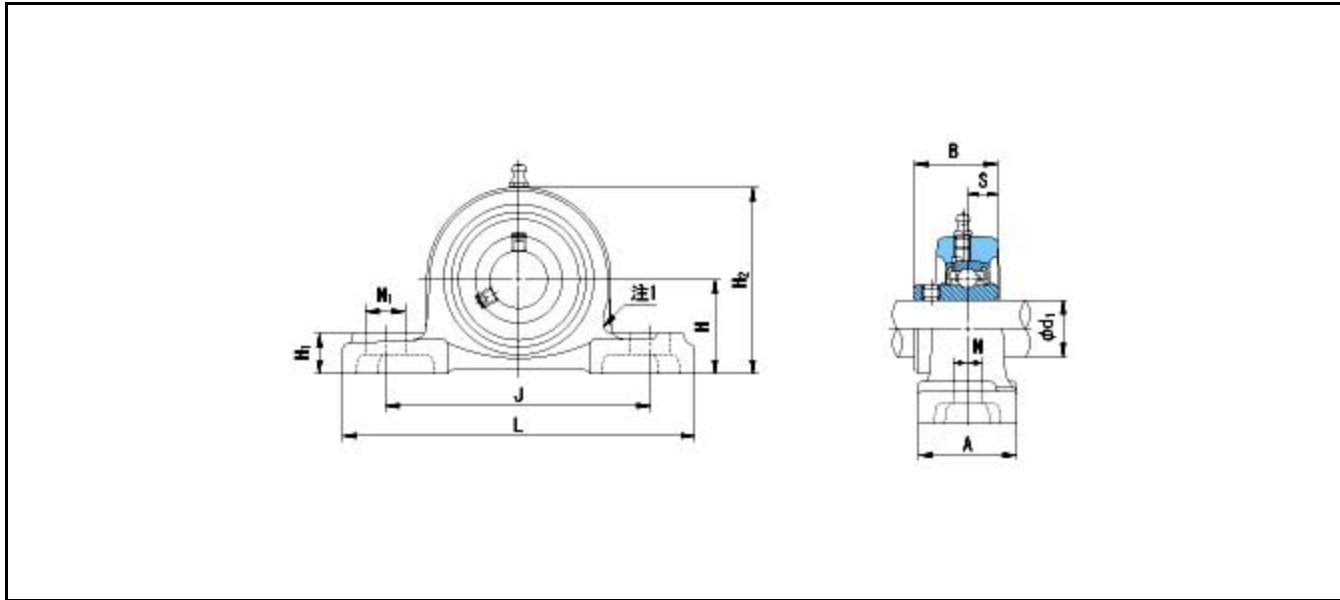

Dimensions

d1 = 85

A = 110

N = 33

B = 96

S = 40

Mass = 18.6 kg

Basic Dynamic Load Rating Cr :	<b>132000 N</b>			
Basic Static Load Rating Cor :	<b>96500 N</b>	O.D.Surface Runout with Side :		-
Limiting Speed ;		Axial Runout with Bore :		-
Grease Lubrication :	- rpm	Axial Runout with Raceway :		-
Oil Lubrication :	- rpm	Width Variation :		-
		Radial Runout :		-