

ROECO

# Bearing Data

## Ball Bearing Units

Bearing No. : **UCP316**

Dimensions

H = 106

L = 400

J = 300

N1 = 40

H1 = 45

H2 = 209

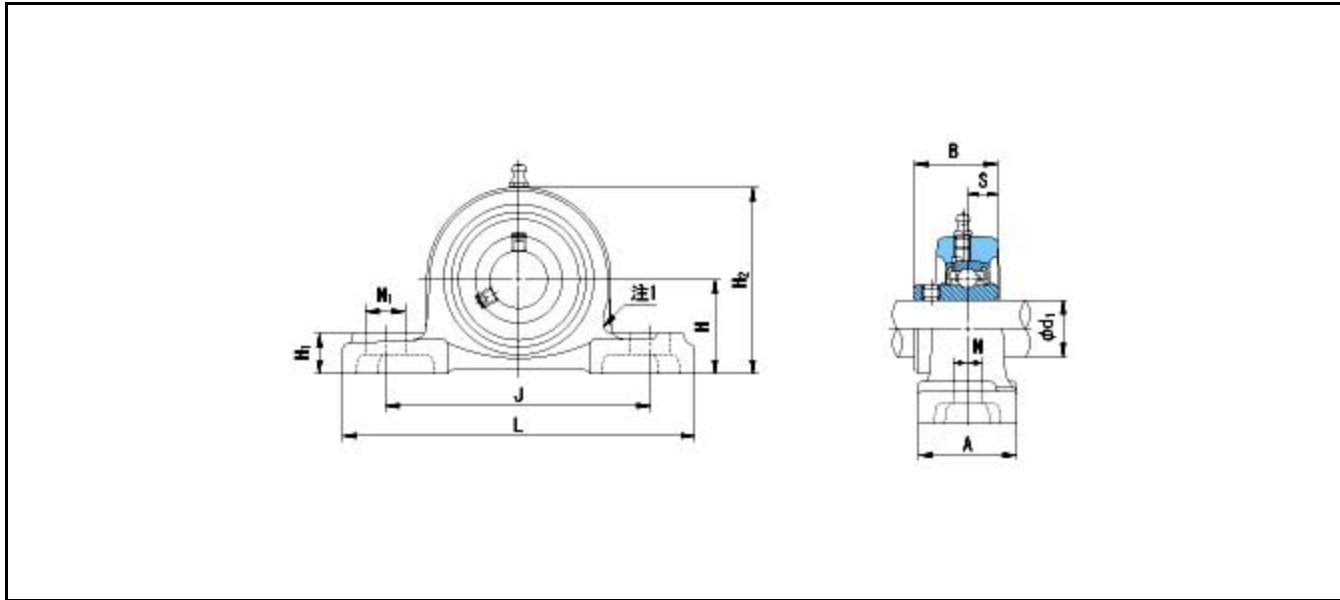

Dimensions

d1 = 80

A = 110

N = 27

B = 86

S = 34

Mass = 16.4 kg

Basic Dynamic Load Rating Cr :	<b>123000 N</b>		
Basic Static Load Rating Cor :	<b>86400 N</b>	O.D.Surface Runout with Side :	-
Limiting Speed ;		Axial Runout with Bore :	-
Grease Lubrication :	- rpm	Axial Runout with Raceway :	-
Oil Lubrication :	- rpm	Width Variation :	-
		Radial Runout :	-