

ROECO

Bearing Data

Ball Bearing Units

Bearing No. : **UCP312**

Dimensions

H = 85
L = 330
J = 250
N1 = 38
H1 = 33
H2 = 165

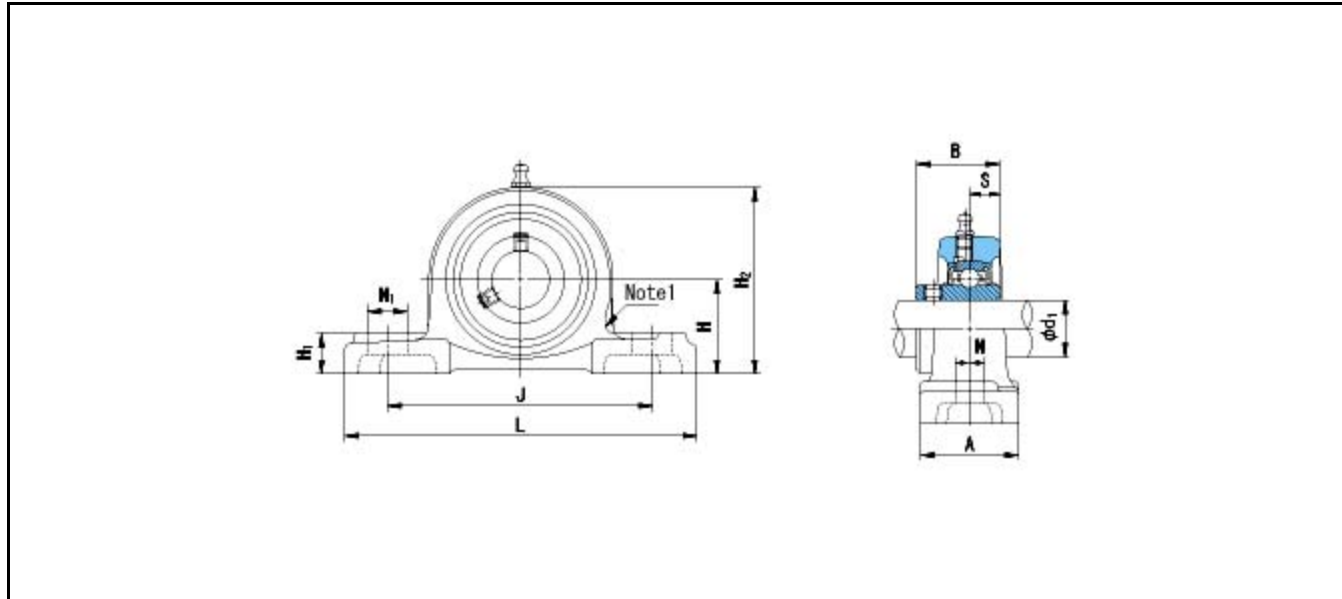

Dimensions

d1 = 60
A = 85
N = 25
B = 71
S = 26
Mass = 9.3 kg

Basic Dynamic Load Rating Cr :	81500 N		INNER RING	OUTER RING
Basic Static Load Rating Cor :	52000 N	O.D.Surface Runout with Side :		-
Limiting Speed ;		Axial Runout with Bore :	-	-
Grease Lubrication :	- rpm	Axial Runout with Raceway :	-	-
Oil Lubrication :	- rpm	Width Variation :	-	-
		Radial Runout :	-	-