

ROECO

Bearing Data

Ball Bearing Units

Bearing No. : **UCP306**

Dimensions

H = 50
L = 180
J = 140
N1 = 20
H1 = 19
H2 = 94

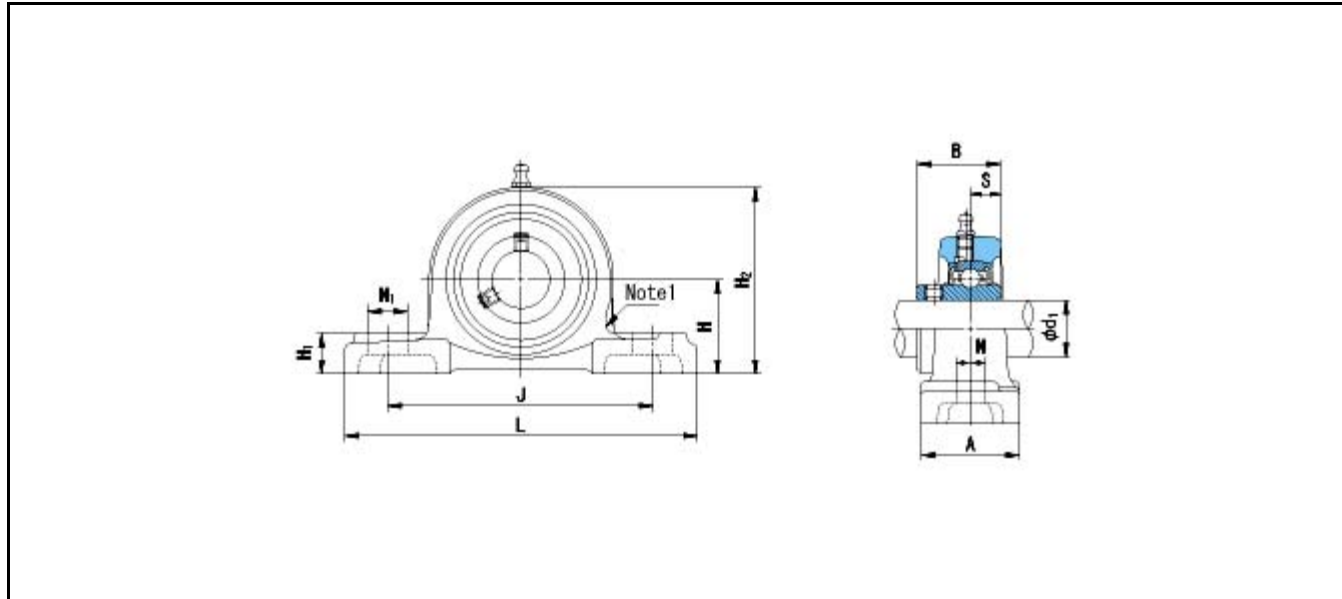

Dimensions

d1 = 30
A = 50
N = 17
B = 43
S = 17
Mass = 1.9 kg

Basic Dynamic Load Rating Cr :	26800 N		INNER RING	OUTER RING
Basic Static Load Rating Cor :	15000 N	O.D.Surface Runout with Side :		-
Limiting Speed ;		Axial Runout with Bore :	-	-
Grease Lubrication :	- rpm	Axial Runout with Raceway :	-	-
Oil Lubrication :	- rpm	Width Variation :	-	-
		Radial Runout :	-	-