

ROECO

Bearing Data

Ball Bearing Units

Bearing No. : **UCP203**

Dimensions

H = 30.2

L = 127

J = 95

N1 = 19

H1 = 15

H2 = 62

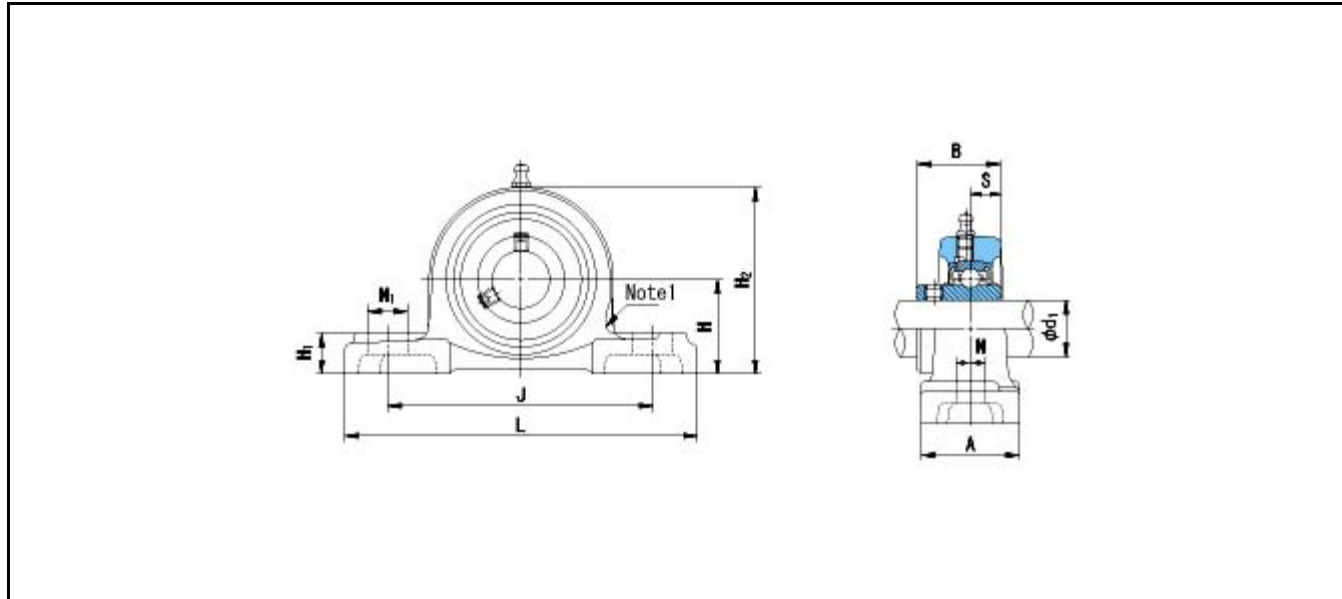

Dimensions

d1 = 17

A = 38

N = 13

B = 31

S = 12.7

Mass = 0.62 kg

Basic Dynamic Load Rating Cr :	12800 N	INNER RING	OUTER RING
Basic Static Load Rating Cor :	6600 N	O.D.Surface Runout with Side :	-
Limiting Speed ;		Axial Runout with Bore :	-
Grease Lubrication :	- rpm	Axial Runout with Raceway :	-
Oil Lubrication :	- rpm	Width Variation :	-
		Radial Runout :	-