

ROECO

Bearing Data

Ball Bearing Units

Bearing No. : **UCHB 207**

Dimensions

$g = 24$

$B_i = 42.9$

$n = 17.5$

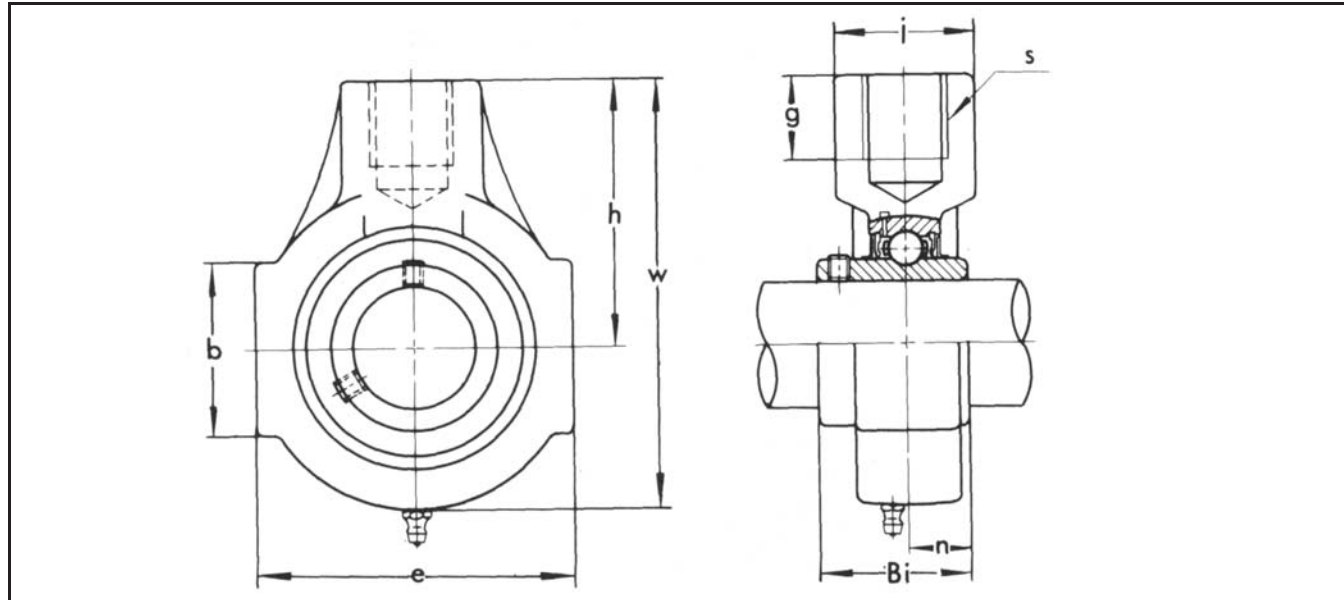

Dimensions

$d_1 = 35$

$e = 90$

$w = 122$

$h = 76$

$b = 49$

$i = 40$

$s = M24$

Mass = 1.40 kg

Basic Dynamic Load Rating C_r : **26200 N**

Basic Static Load Rating C_{or} : **20300 N**

Limiting Speed ;

Grease Lubrication : - rpm

Oil Lubrication : - rpm

INNER RING OUTER RING

O.D.Surface Runout with Side : -

Axial Runout with Bore : -

Axial Runout with Raceway : -

Width Variation : -

Radial Runout : -