

ROECO

Bearing Data

Ball Bearing Units

Bearing No. : **UCHB 205**

Dimensions

$g = 22$

$B_i = 34$

$n = 14.3$

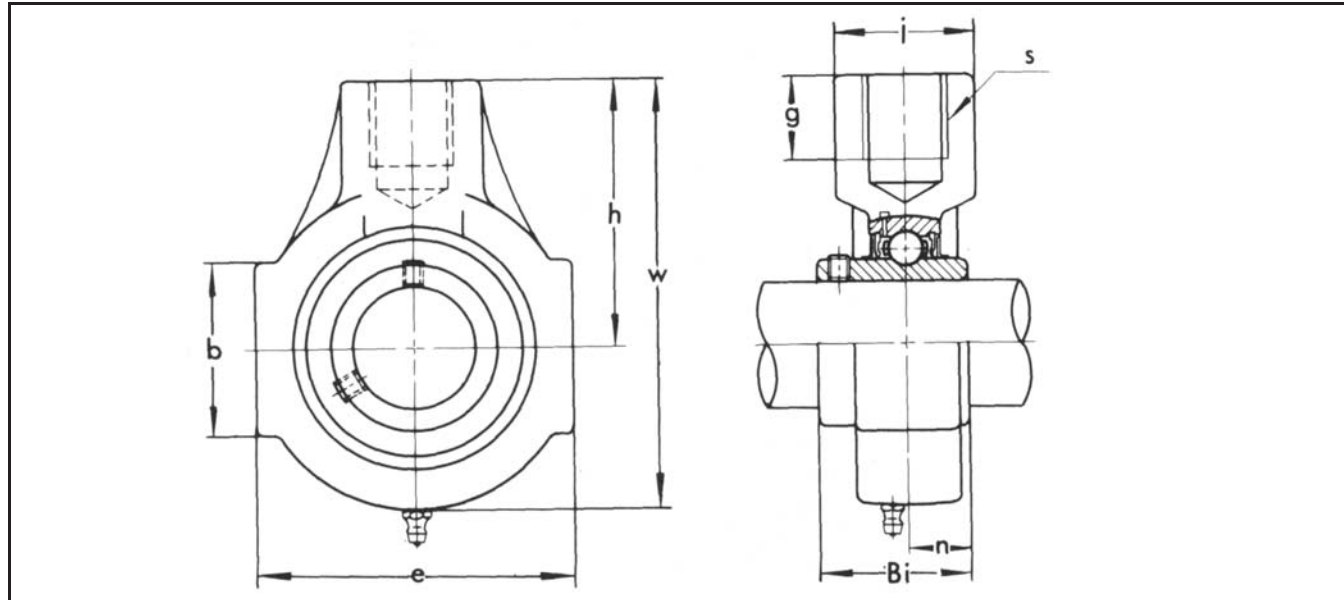

Dimensions

$d_1 = 25$

$e = 70$

$w = 99$

$h = 64$

$b = 38$

$i = 35$

$s = M20$

Mass = 0.80 kg

Basic Dynamic Load Rating C_r : **14300 N**

Basic Static Load Rating C_{or} : **11000 N**

Limiting Speed ;

Grease Lubrication : - rpm

Oil Lubrication : - rpm

INNER RING OUTER RING

O.D.Surface Runout with Side : -

Axial Runout with Bore : -

Axial Runout with Raceway : -

Width Variation : -

Radial Runout : -