

ROECO

Bearing Data

Ball Bearing Units

Bearing No. : **UCFX20**

Dimensions

L = 268

J = 211

N = 31

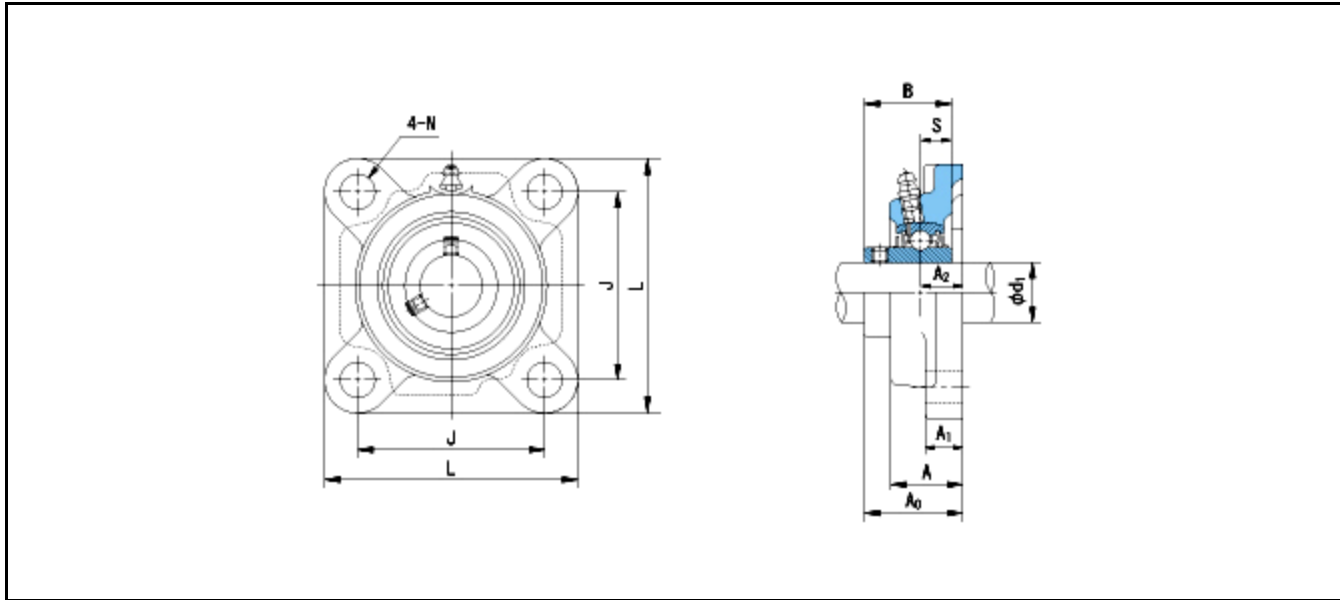

Dimensions

d1 = 100

A1 = 31

A2 = 59

B = 117.5

S = 49.2

A = 97

A0 = 127.3

Mass = 16.8 kg

Basic Dynamic Load Rating Cr :	134000 N			
Basic Static Load Rating Cor :	104700 N	O.D.Surface Runout with Side :		-
Limiting Speed ;		Axial Runout with Bore :		-
Grease Lubrication :	- rpm	Axial Runout with Raceway :		-
Oil Lubrication :	- rpm	Width Variation :		-
		Radial Runout :		-