

ROECO

Bearing Data

Ball Bearing Units

Bearing No. : **UCFX14**

Dimensions

L = 197

J = 152

N = 23

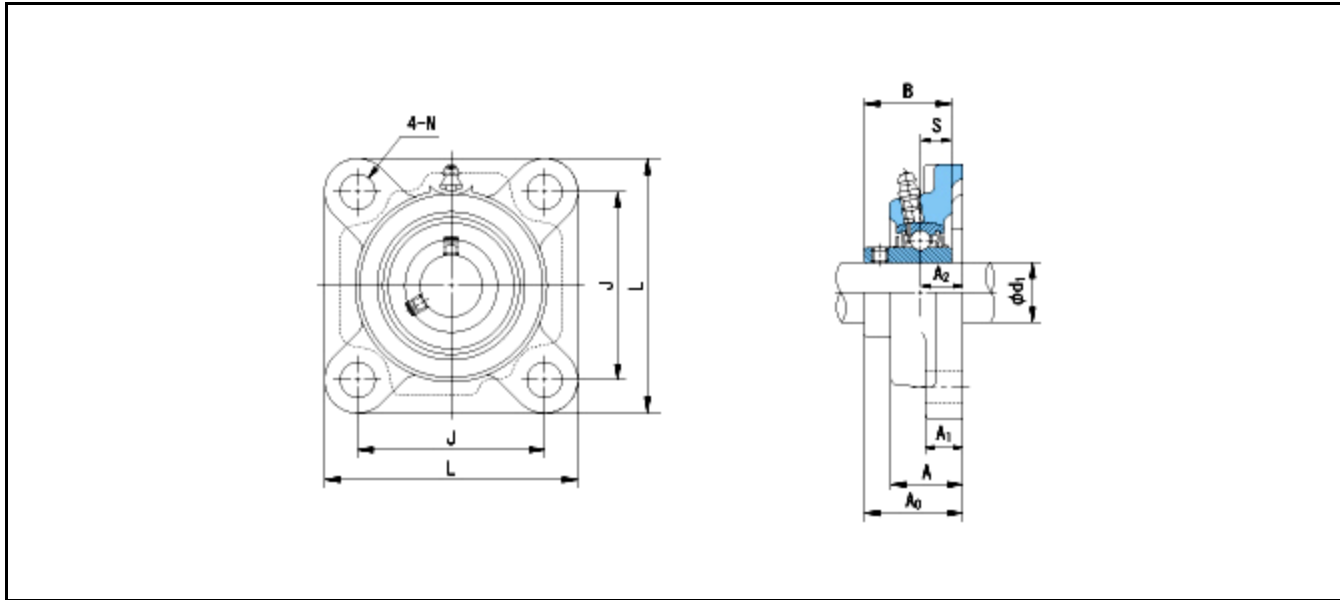

Dimensions

d1 = 70

A1 = 24

A2 = 37

B = 77.8

S = 33.3

A = 60

A0 = 81.5

Mass = 7.7 kg

Basic Dynamic Load Rating Cr :	66000 N				
Basic Static Load Rating Cor :	48200 N	O.D.Surface Runout with Side :			-
Limiting Speed ;		Axial Runout with Bore :			-
Grease Lubrication :	- rpm	Axial Runout with Raceway :			-
Oil Lubrication :	- rpm	Width Variation :			-
		Radial Runout :			-