

ROECO

Bearing Data

Ball Bearing Units

Bearing No. : **UCFX06**

Dimensions

L = 117

J = 92

N = 16

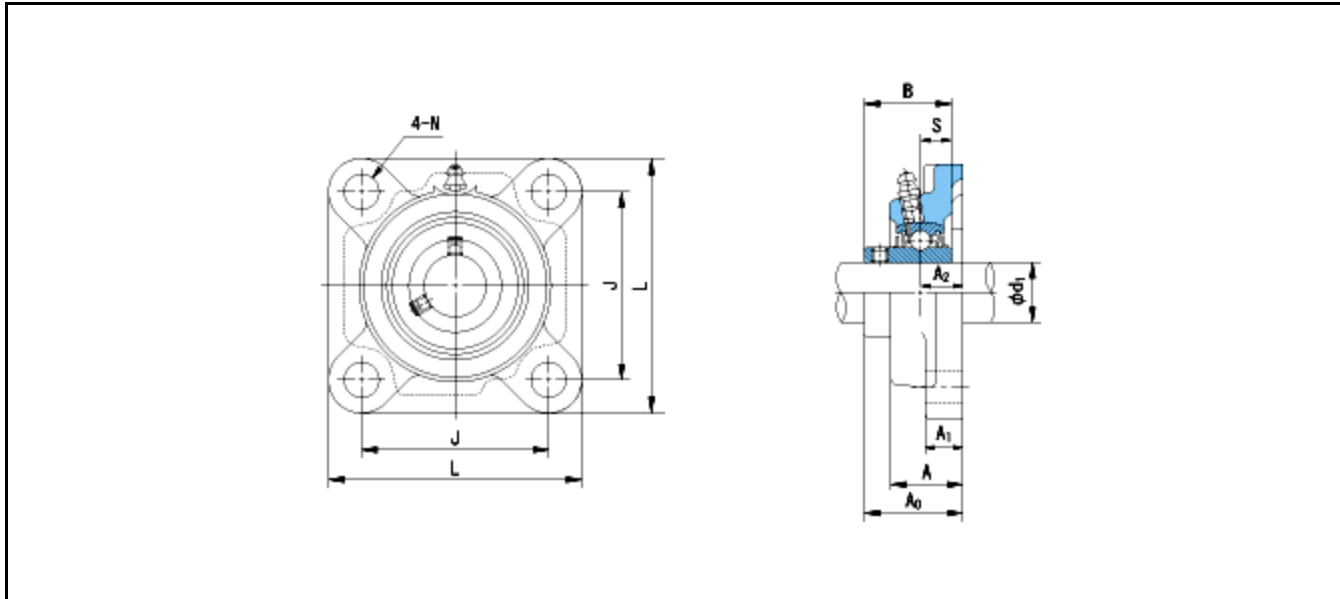

Dimensions

d1 = 30

A1 = 14

A2 = 19

B = 42.9

S = 17.5

A = 34

A0 = 44.4

Mass = 1.3 kg

Basic Dynamic Load Rating Cr :	25900 N				
Basic Static Load Rating Cor :	15400 N	O.D.Surface Runout with Side :			-
Limiting Speed ;		Axial Runout with Bore :			-
Grease Lubrication :	- rpm	Axial Runout with Raceway :			-
Oil Lubrication :	- rpm	Width Variation :			-
		Radial Runout :			-