

ROECO

# Bearing Data

## Ball Bearing Units

Bearing No. : **UCFX05E**

Dimensions

L = 108

J = 83

N = 12

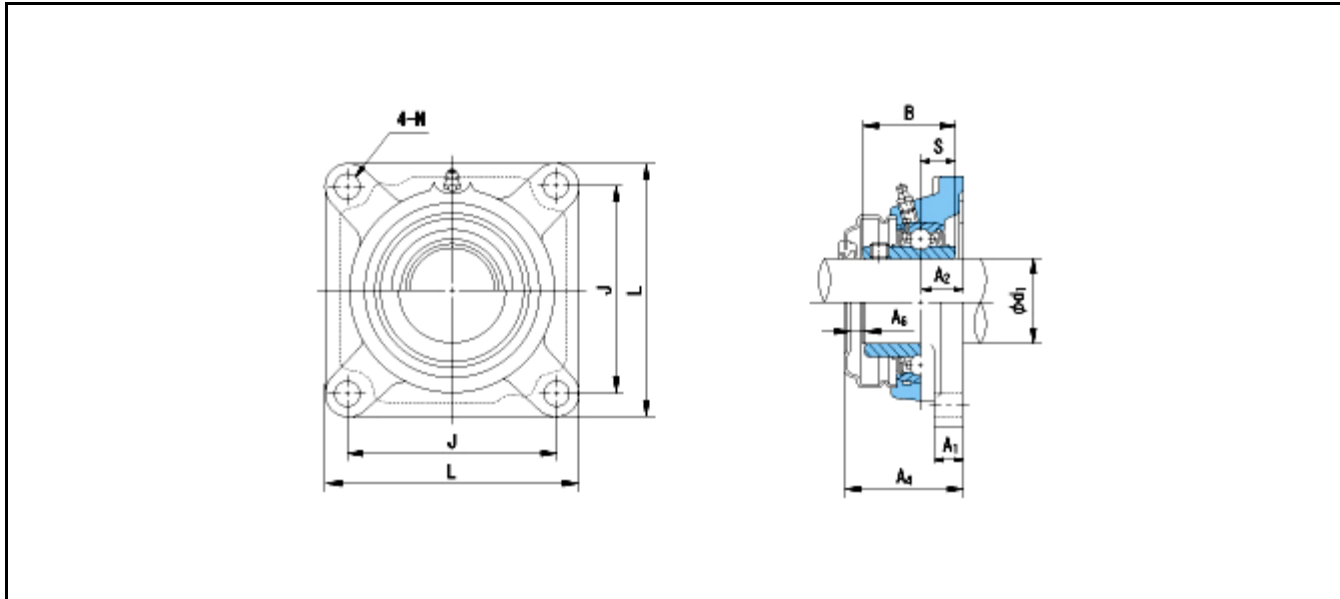

Dimensions

d1 = 25

A1 = 13

A2 = 18

B = 38.1

S = 15.9

A4 = 51

A6 = 9

Mass = 1.2 kg

Basic Dynamic Load Rating Cr :	<b>19600 N</b>				
Basic Static Load Rating Cor :	<b>11300 N</b>	O.D.Surface Runout with Side :			-
Limiting Speed ;		Axial Runout with Bore :			-
Grease Lubrication :	- rpm	Axial Runout with Raceway :			-
Oil Lubrication :	- rpm	Width Variation :			-
		Radial Runout :			-