

ROECO

Bearing Data

Ball Bearing Units

Bearing No. : **UCFS313**

Dimensions

L = 208

J = 166

N = 23

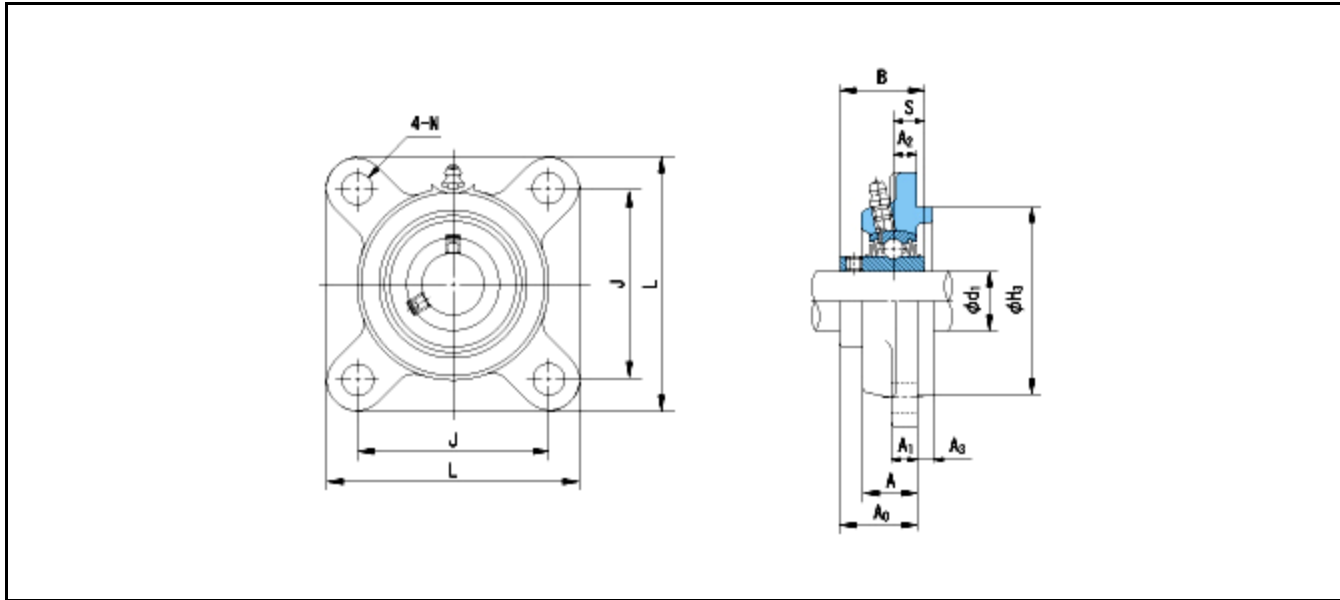

Dimensions

d1 = 65

A1 = 22

A2 = 15

H3 = 175

B = 75

S = 30

A = 40

A0 = 60

Mass = 8.6 kg

Basic Dynamic Load Rating Cr :	92500 N		
Basic Static Load Rating Cor :	59700 N	O.D.Surface Runout with Side :	-
Limiting Speed ;		Axial Runout with Bore :	-
Grease Lubrication :	- rpm	Axial Runout with Raceway :	-
Oil Lubrication :	- rpm	Width Variation :	-
		Radial Runout :	-