

ROECO

Bearing Data

Ball Bearing Units

Bearing No. : **UCFS312**

Dimensions

L = 195

J = 150

N = 23

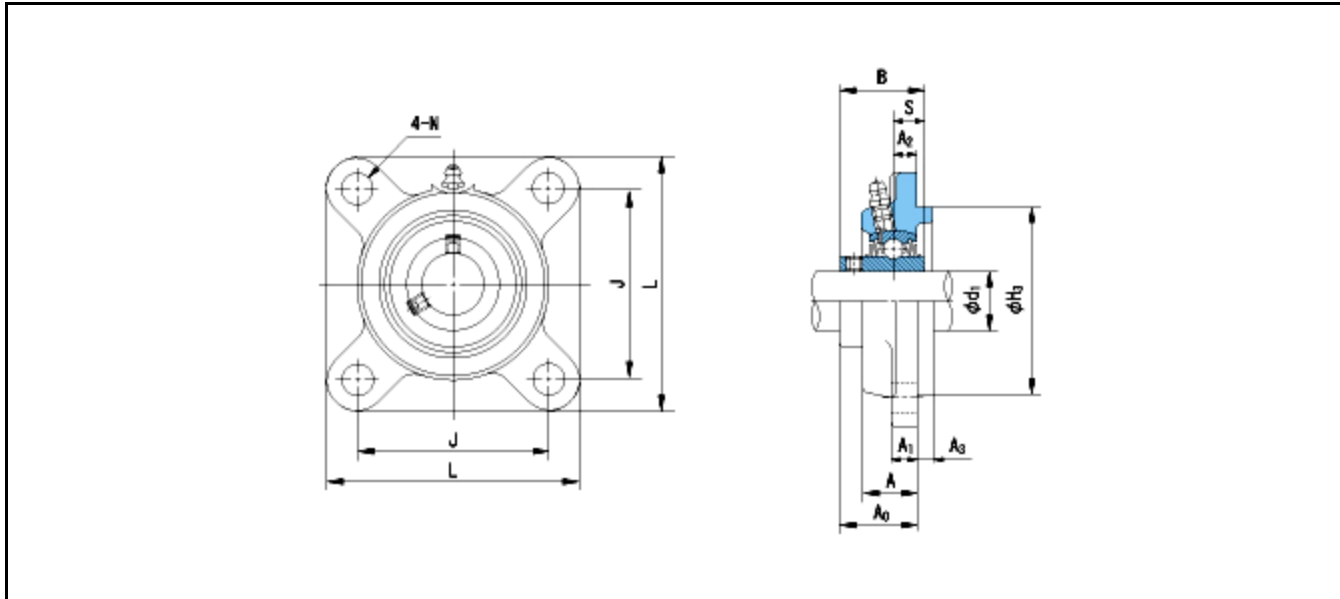

Dimensions

d1 = 60

A1 = 22

A2 = 19

H3 = 160

B = 71

S = 26

A = 42

A0 = 64

Mass = 7.4 kg

Basic Dynamic Load Rating Cr :	81500 N		
Basic Static Load Rating Cor :	52000 N	O.D.Surface Runout with Side :	-
Limiting Speed ;		Axial Runout with Bore :	-
Grease Lubrication :	- rpm	Axial Runout with Raceway :	-
Oil Lubrication :	- rpm	Width Variation :	-
		Radial Runout :	-

INNER RING OUTER RING