

ROECO

Bearing Data

Ball Bearing Units

Bearing No. : **UCFS311**

Dimensions

L = 185

J = 140

N = 23

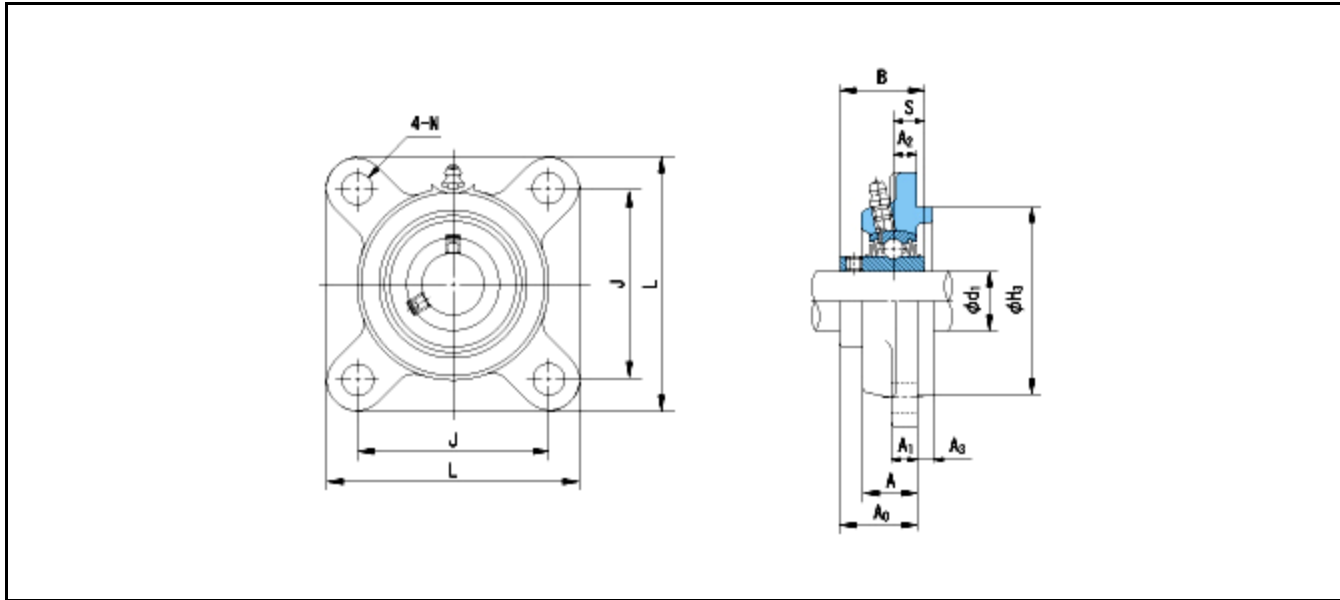

Dimensions

d1 = 55

A1 = 20

A2 = 17

H3 = 150

B = 66

S = 25

A = 39

A0 = 58

Mass = 6.2 kg

Basic Dynamic Load Rating Cr :	71500 N		
Basic Static Load Rating Cor :	44800 N	O.D.Surface Runout with Side :	-
Limiting Speed ;		Axial Runout with Bore :	-
Grease Lubrication :	- rpm	Axial Runout with Raceway :	-
Oil Lubrication :	- rpm	Width Variation :	-
		Radial Runout :	-