

ROECO

Bearing Data

Ball Bearing Units

Bearing No. : **UCFS308**

Dimensions

L = 150

J = 112

N = 19

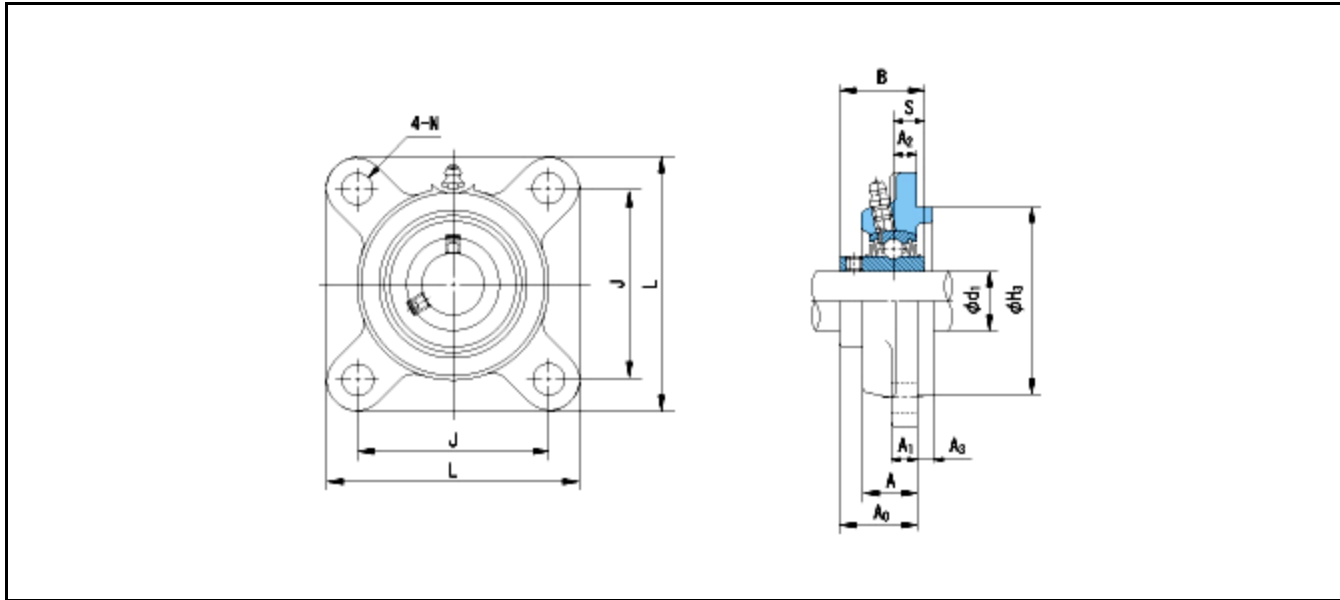

Dimensions

d1 = 40

A1 = 17

A2 = 13

H3 = 115

B = 52

S = 19

A = 30

A0 = 46

Mass = 3.3 kg

Basic Dynamic Load Rating Cr :	40500 N		
Basic Static Load Rating Cor :	23900 N	O.D.Surface Runout with Side :	-
Limiting Speed ;		Axial Runout with Bore :	-
Grease Lubrication :	- rpm	Axial Runout with Raceway :	-
Oil Lubrication :	- rpm	Width Variation :	-
		Radial Runout :	-