

ROECO

Bearing Data

Ball Bearing Units

Bearing No. : **UCFS307**

Dimensions

L = 135

J = 100

N = 19

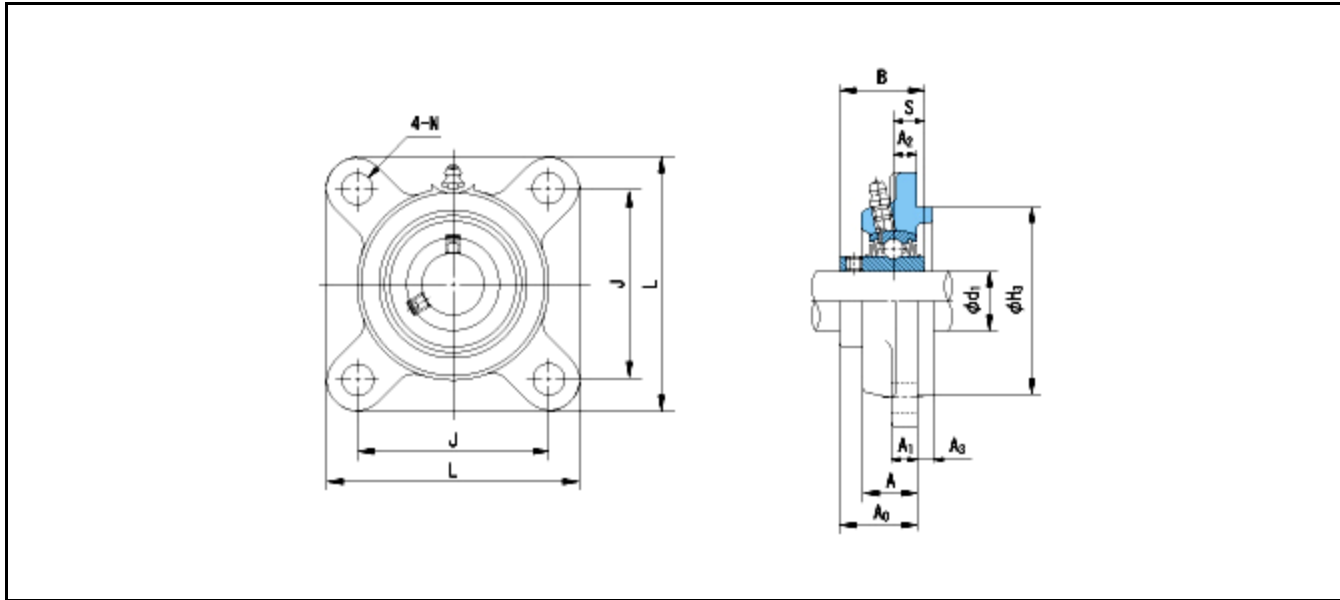

Dimensions

d1 = 35

A1 = 16

A2 = 11

H3 = 100

B = 48

S = 19

A = 27

A0 = 40

Mass = 2.4 kg

Basic Dynamic Load Rating Cr :	33500 N		
Basic Static Load Rating Cor :	19200 N	O.D.Surface Runout with Side :	-
Limiting Speed ;		Axial Runout with Bore :	-
Grease Lubrication :	- rpm	Axial Runout with Raceway :	-
Oil Lubrication :	- rpm	Width Variation :	-
		Radial Runout :	-