

ROECO

Bearing Data

Ball Bearing Units

Bearing No. : **UCFS305**

Dimensions

L = 110

J = 80

N = 16

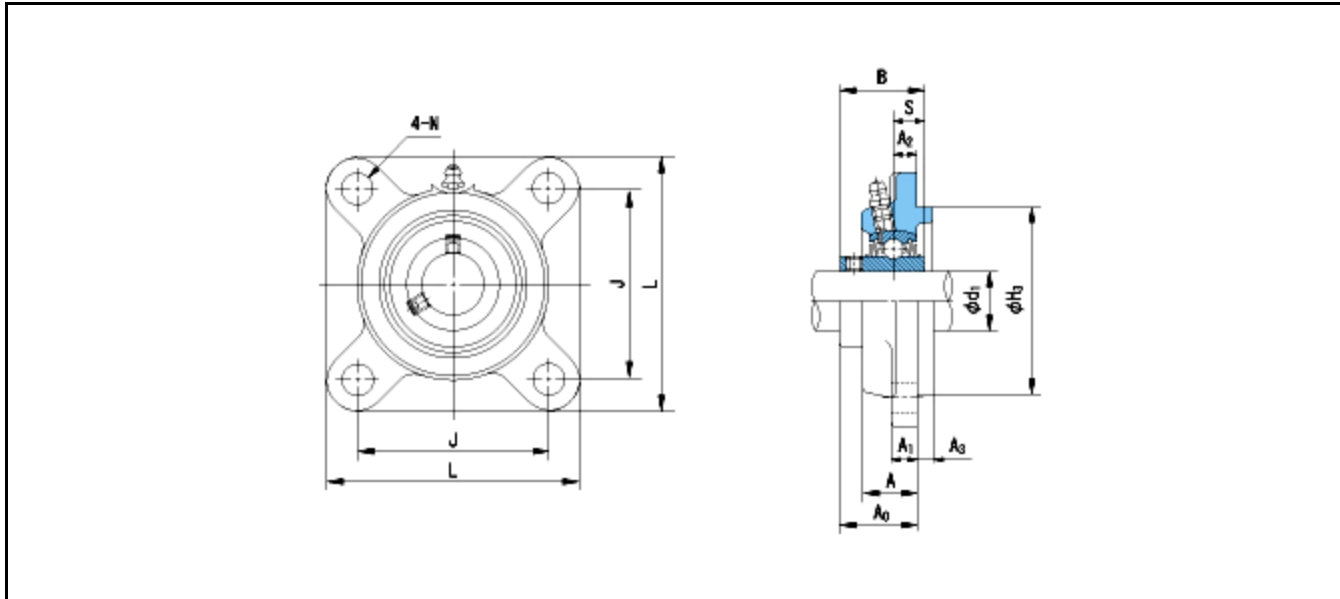

Dimensions

d1 = 25

A1 = 13

A2 = 9

H3 = 80

B = 38

S = 15

A = 22

A0 = 32

Mass = 1.4 kg

Basic Dynamic Load Rating Cr :	21300 N		
Basic Static Load Rating Cor :	10900 N	O.D.Surface Runout with Side :	-
Limiting Speed ;		Axial Runout with Bore :	-
Grease Lubrication :	- rpm	Axial Runout with Raceway :	-
Oil Lubrication :	- rpm	Width Variation :	-
		Radial Runout :	-