

ROECO

Bearing Data

Ball Bearing Units

Bearing No. : **UCFLX09C**

Dimensions

H = 189

L = 116

J = 157

N = 16

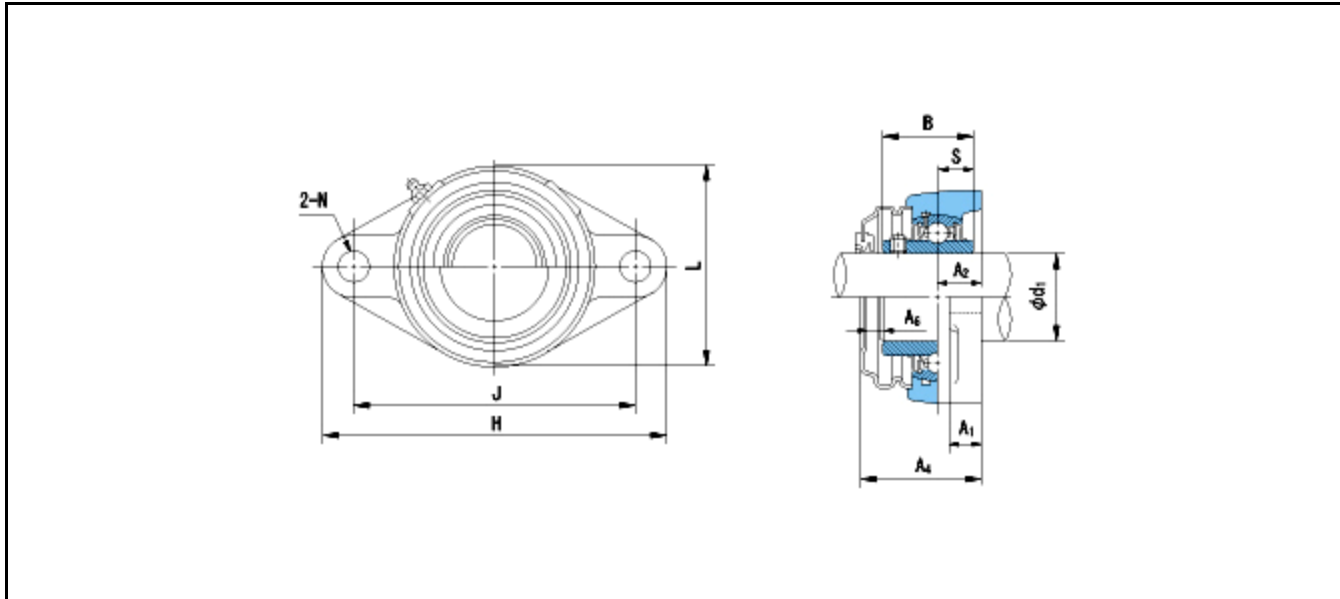

Dimensions

d1 = 45

A1 = 14

A2 = 23

A4 = 67

A6 = 9

B = 51.6

S = 19

Mass = 2.5 kg

Basic Dynamic Load Rating Cr :	35500 N		
Basic Static Load Rating Cor :	23200 N	O.D.Surface Runout with Side :	-
Limiting Speed ;		Axial Runout with Bore :	-
Grease Lubrication :	- rpm	Axial Runout with Raceway :	-
Oil Lubrication :	- rpm	Width Variation :	-
		Radial Runout :	-