

ROECO

Bearing Data

Ball Bearing Units

Bearing No. : **UCFL205E**

Dimensions

H = 130

L = 68

J = 99

N = 16

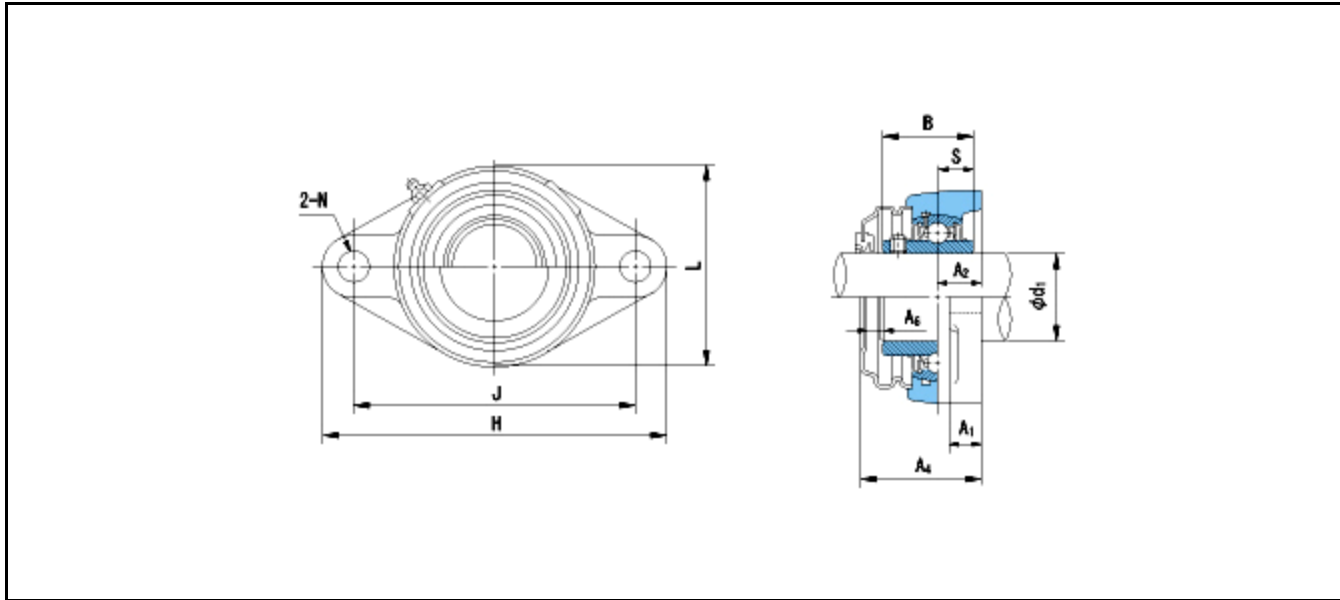

Dimensions

d1 = 25

A1 = 14

A2 = 16

A4 = 47

A6 = 10

B = 34

S = 14.3

Mass = 0.67 kg

Basic Dynamic Load Rating Cr :	14000 N	INNER RING	OUTER RING
Basic Static Load Rating Cor :	7900 N	O.D.Surface Runout with Side :	-
Limiting Speed ;		Axial Runout with Bore :	-
Grease Lubrication :	- rpm	Axial Runout with Raceway :	-
Oil Lubrication :	- rpm	Width Variation :	-
		Radial Runout :	-