

ROECO

Bearing Data

Ball Bearing Units

Bearing No. : **UCFL319**

Dimensions

H = 405

L = 250

J = 330

N = 41

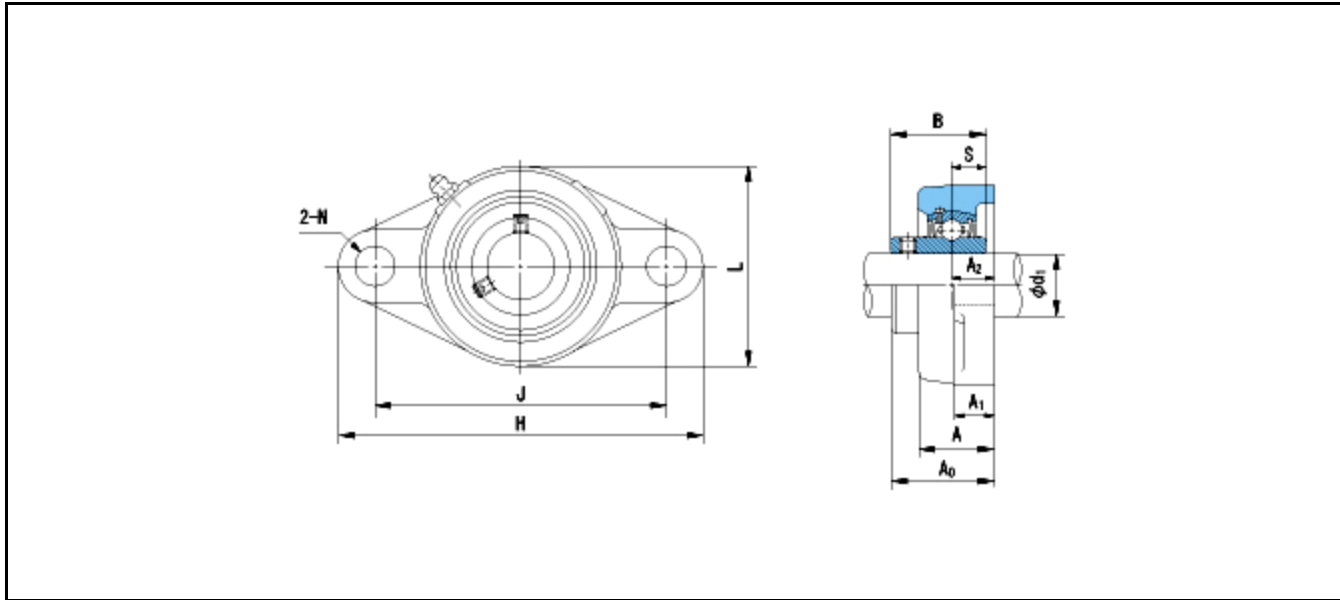

Dimensions

d1 = 95

A1 = 40

A2 = 59

A = 94

A0 = 121

B = 103

S = 41

Mass = 21.8 kg

Basic Dynamic Load Rating Cr :	153000 N			
Basic Static Load Rating Cor :	118400 N	O.D.Surface Runout with Side :		-
Limiting Speed ;		Axial Runout with Bore :		-
Grease Lubrication :	- rpm	Axial Runout with Raceway :		-
Oil Lubrication :	- rpm	Width Variation :		-
		Radial Runout :		-