

ROECO

Bearing Data

Ball Bearing Units

Bearing No. : UCFL318

Dimensions

H = 385

L = 235

J = 315

N = 38

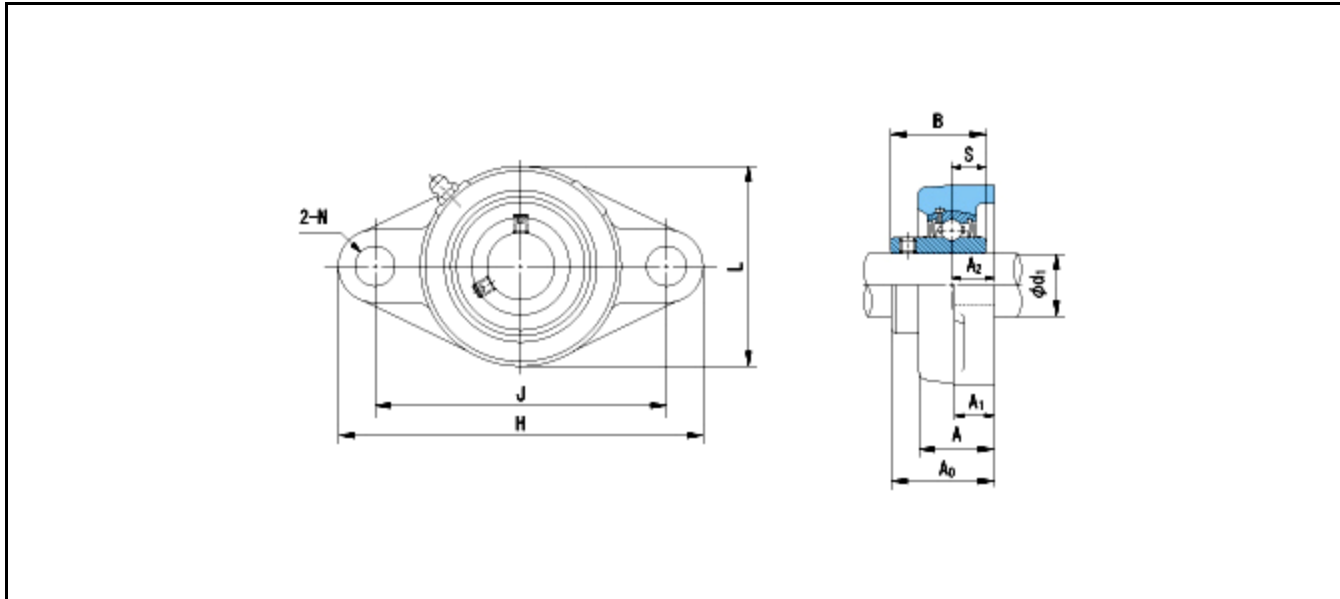

Dimensions

d1 = 90

A1 = 36

A2 = 44

A = 76

A0 = 100

B = 96

S = 40

Mass = 17.1 kg

Basic Dynamic Load Rating Cr :	143000 N			
Basic Static Load Rating Cor :	107200 N	O.D.Surface Runout with Side :		-
Limiting Speed ;		Axial Runout with Bore :		-
Grease Lubrication :	- rpm	Axial Runout with Raceway :		-
Oil Lubrication :	- rpm	Width Variation :		-
		Radial Runout :		-