

ROECO

Bearing Data

Ball Bearing Units

Bearing No. : **UCFL317**

Dimensions

H = 370

L = 220

J = 300

N = 38

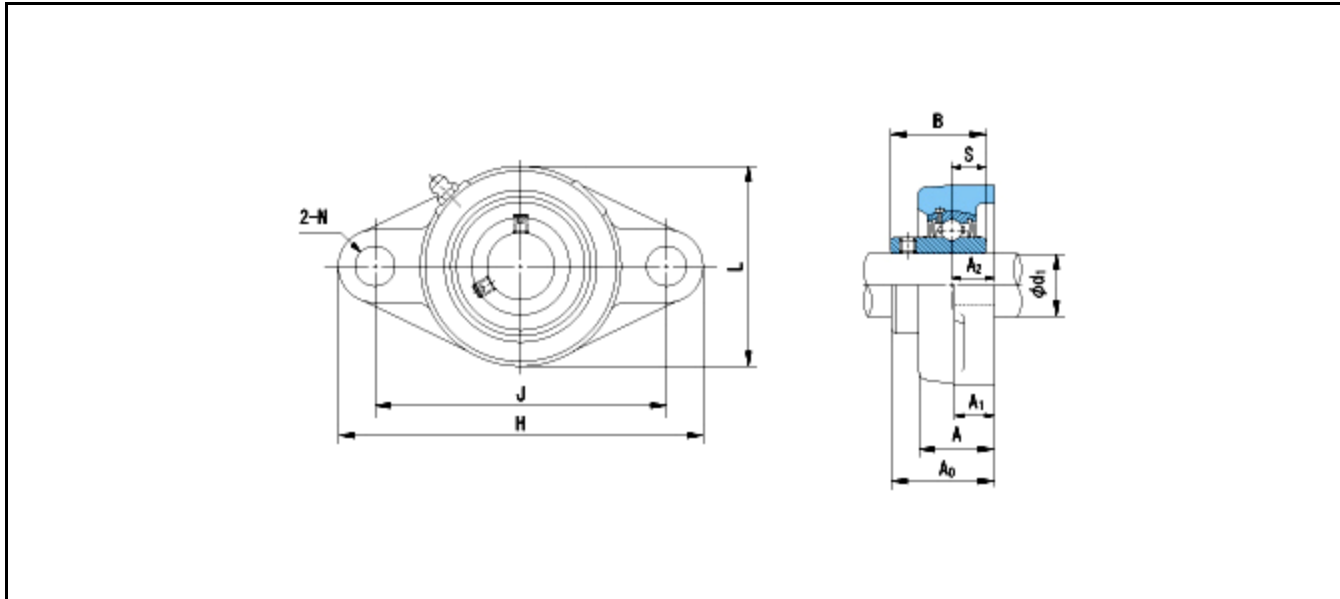

Dimensions

d1 = 80

A1 = 32

A2 = 44

A = 74

A0 = 100

B = 96

S = 40

Mass = 14.5 kg

Basic Dynamic Load Rating Cr :	132000 N			
Basic Static Load Rating Cor :	96500 N	O.D.Surface Runout with Side :		-
Limiting Speed ;		Axial Runout with Bore :		-
Grease Lubrication :	- rpm	Axial Runout with Raceway :		-
Oil Lubrication :	- rpm	Width Variation :		-
		Radial Runout :		-