

ROECO

Bearing Data

Ball Bearing Units

Bearing No. : **UCFL313**

Dimensions

H = 295

L = 175

J = 240

N = 31

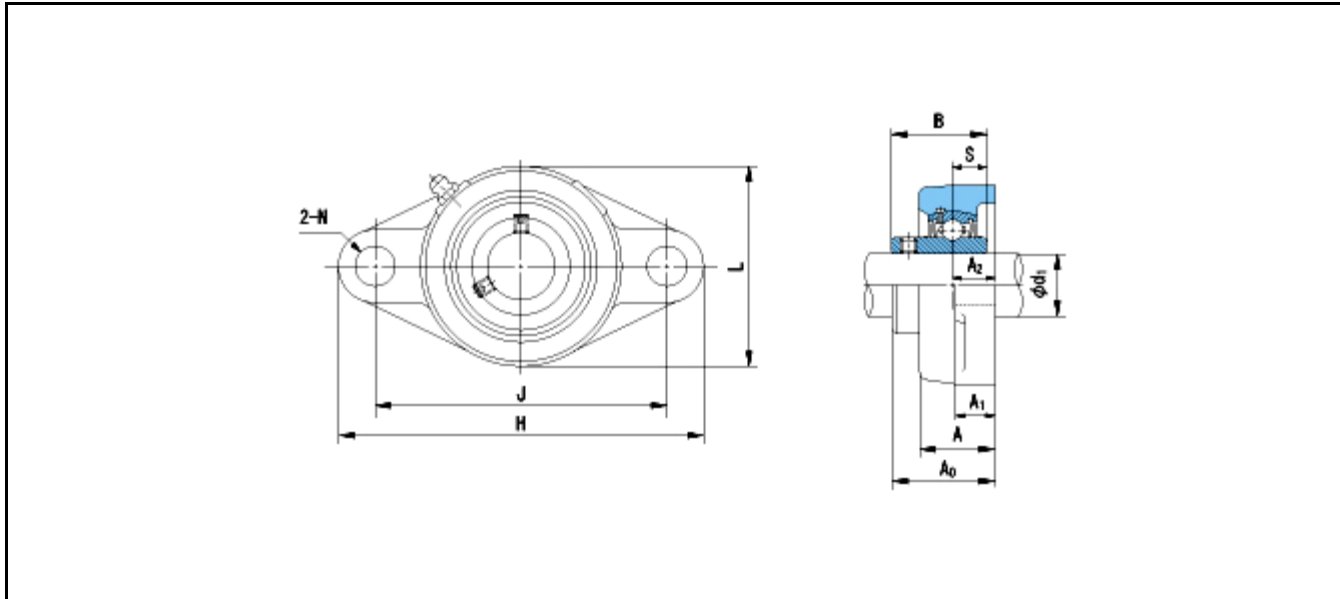

Dimensions

d1 = 65

A1 = 25

A2 = 33

A = 58

A0 = 78

B = 75

S = 30

Mass = 7.4 kg

Basic Dynamic Load Rating Cr :	92500 N	INNER RING	OUTER RING
Basic Static Load Rating Cor :	59700 N	O.D.Surface Runout with Side :	-
Limiting Speed ;		Axial Runout with Bore :	-
Grease Lubrication :	- rpm	Axial Runout with Raceway :	-
Oil Lubrication :	- rpm	Width Variation :	-
		Radial Runout :	-