

ROECO

Bearing Data

Ball Bearing Units

Bearing No. : **UCFL311**

Dimensions

H = 250

L = 150

J = 198

N = 25

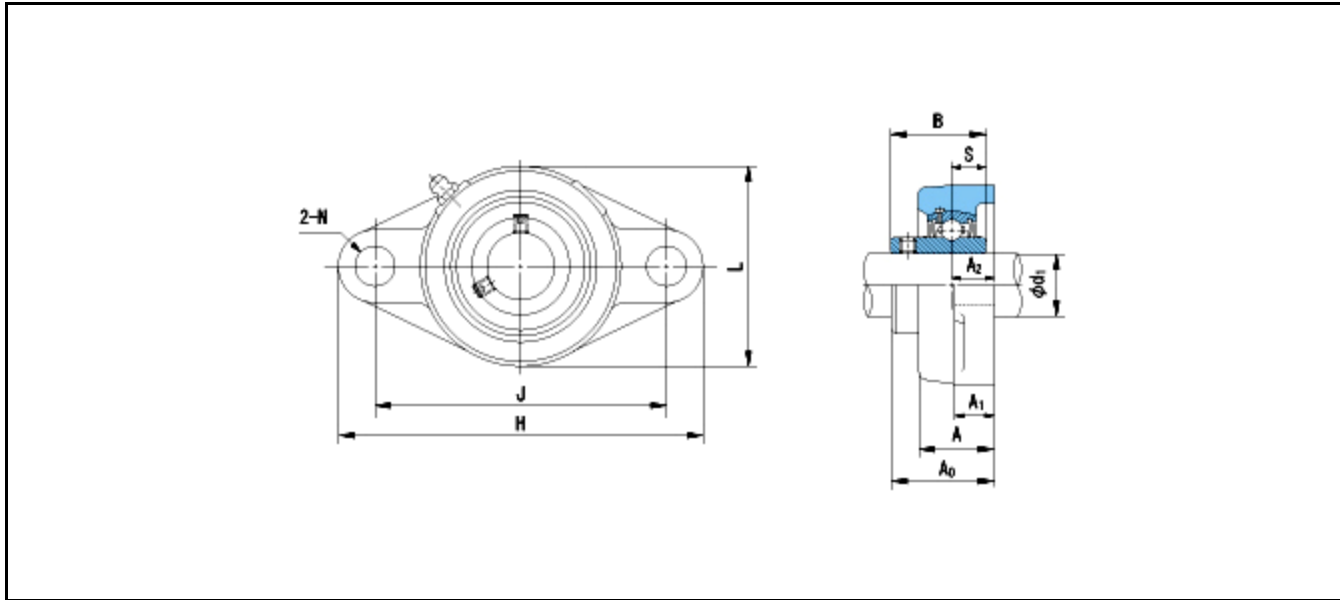

Dimensions

d1 = 55

A1 = 20

A2 = 30

A = 52

A0 = 71

B = 66

S = 25

Mass = 5.1 kg

Basic Dynamic Load Rating Cr :	71500 N	INNER RING	OUTER RING
Basic Static Load Rating Cor :	44800 N	O.D.Surface Runout with Side :	-
Limiting Speed ;		Axial Runout with Bore :	-
Grease Lubrication :	- rpm	Axial Runout with Raceway :	-
Oil Lubrication :	- rpm	Width Variation :	-
		Radial Runout :	-