

ROECO

Bearing Data

Ball Bearing Units

Bearing No. : **UCFL310**

Dimensions

H = 240

L = 140

J = 187

N = 25

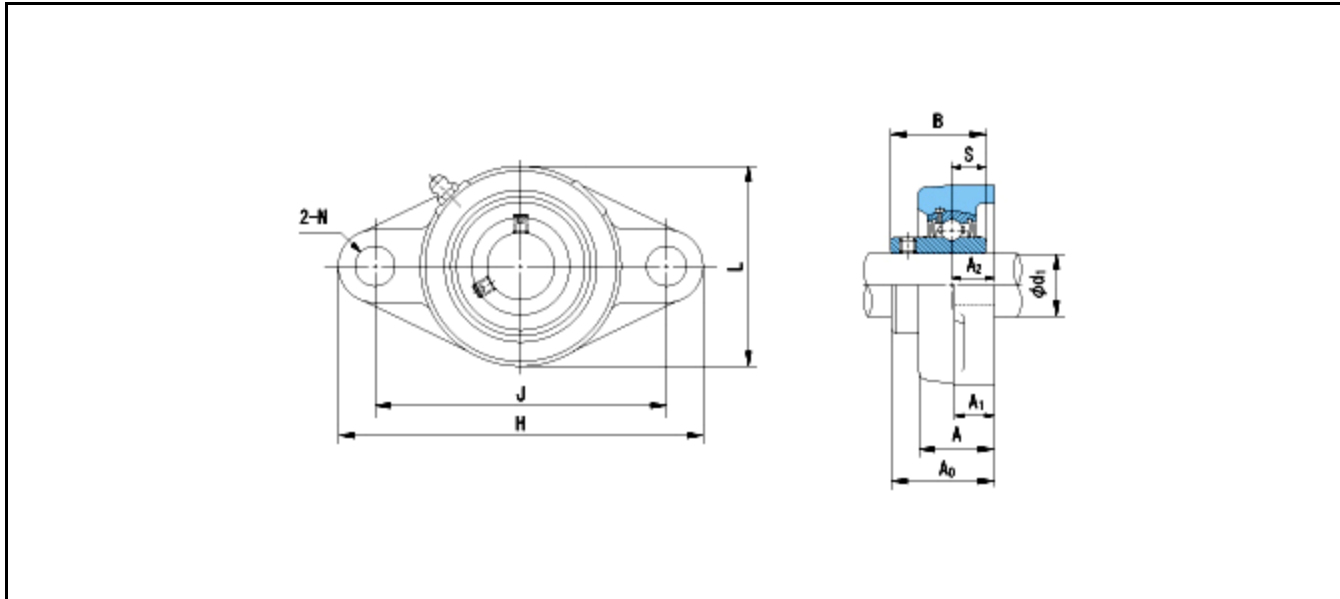

Dimensions

d1 = 50

A1 = 19

A2 = 28

A = 48

A0 = 67

B = 61

S = 22

Mass = 4.3 kg

Basic Dynamic Load Rating Cr :	61500 N	INNER RING	OUTER RING
Basic Static Load Rating Cor :	38200 N	O.D.Surface Runout with Side :	-
Limiting Speed ;		Axial Runout with Bore :	-
Grease Lubrication :	- rpm	Axial Runout with Raceway :	-
Oil Lubrication :	- rpm	Width Variation :	-
		Radial Runout :	-