

ROECO

Bearing Data

Ball Bearing Units

Bearing No. : **UCFL204**

Dimensions

H = 113

L = 60

J = 90

N = 12

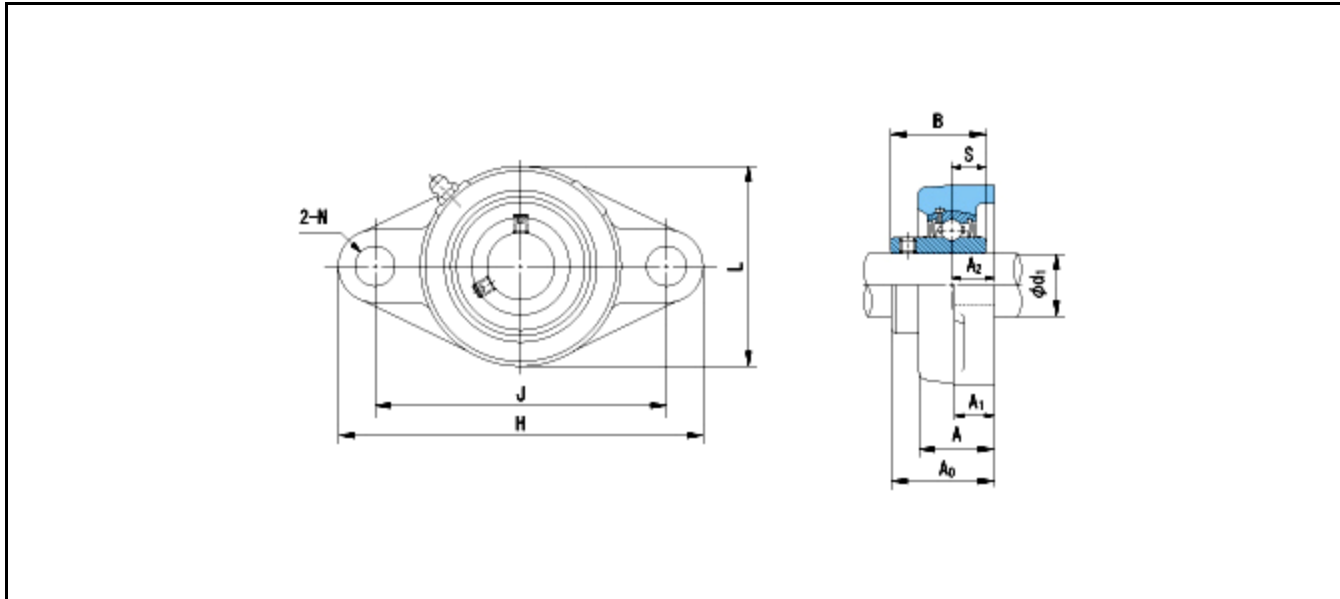

Dimensions

d1 = 20

A1 = 12

A2 = 15

A = 25.5

A0 = 33.3

B = 31

S = 12.7

Mass = 0.45 kg

Basic Dynamic Load Rating Cr :	12800 N	INNER RING	OUTER RING
Basic Static Load Rating Cor :	6600 N	O.D.Surface Runout with Side :	-
Limiting Speed ;		Axial Runout with Bore :	-
Grease Lubrication :	- rpm	Axial Runout with Raceway :	-
Oil Lubrication :	- rpm	Width Variation :	-
		Radial Runout :	-