

ROECO

Bearing Data

Ball Bearing Units

Bearing No. : **UCFC204**

Dimensions

L = 100

J = 78

N = 12

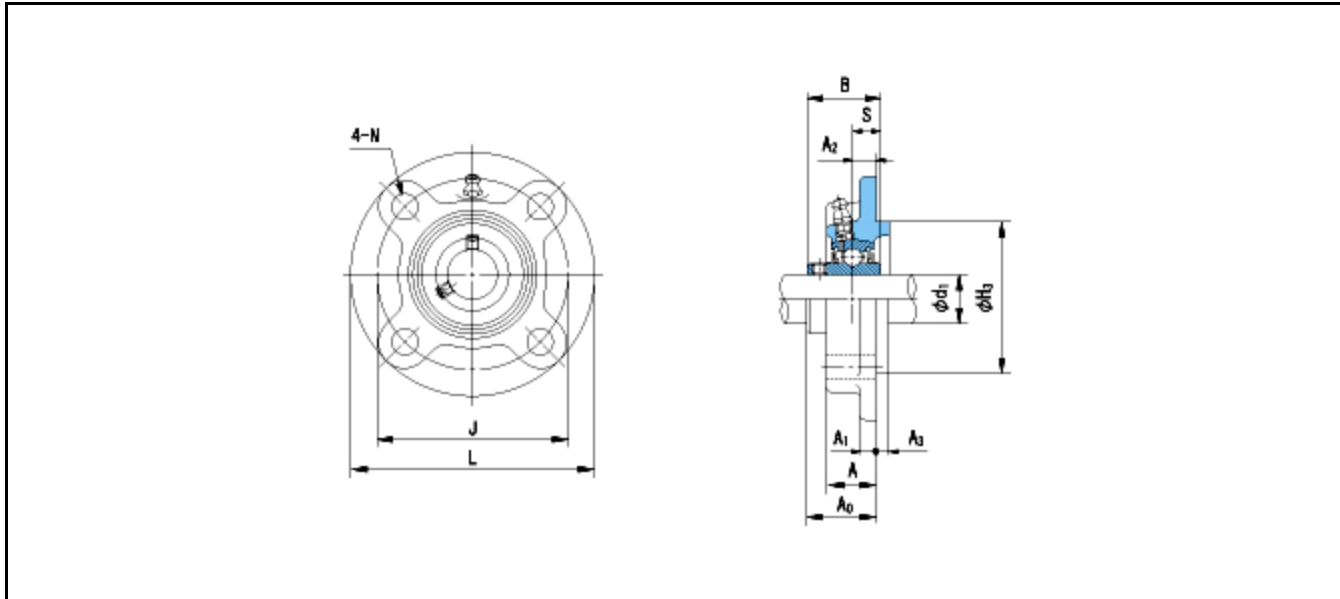

Dimensions

d1 = 20

A = 20.5

A1 = 7

A2 = 10

A3 = 5

H3 = 62

B = 31

S = 12.7

A0 = 28.3

Mass = 0.84 kg

Basic Dynamic Load Rating Cr : **12800 N**

Basic Static Load Rating Cor : **6600 N**

Limiting Speed ;

Grease Lubrication : - rpm

Oil Lubrication : - rpm

INNER RING OUTER RING

O.D.Surface Runout with Side : -

Axial Runout with Bore : -

Axial Runout with Raceway : -

Width Variation : -

Radial Runout : -