

ROECO

# Bearing Data

## Ball Bearing Units

Bearing No. : **UCFA204**

Dimensions

- H = 60
- L = 102
- J = 78
- N = 10
- N2 = 10
- N3 = 40
- H2 = 54

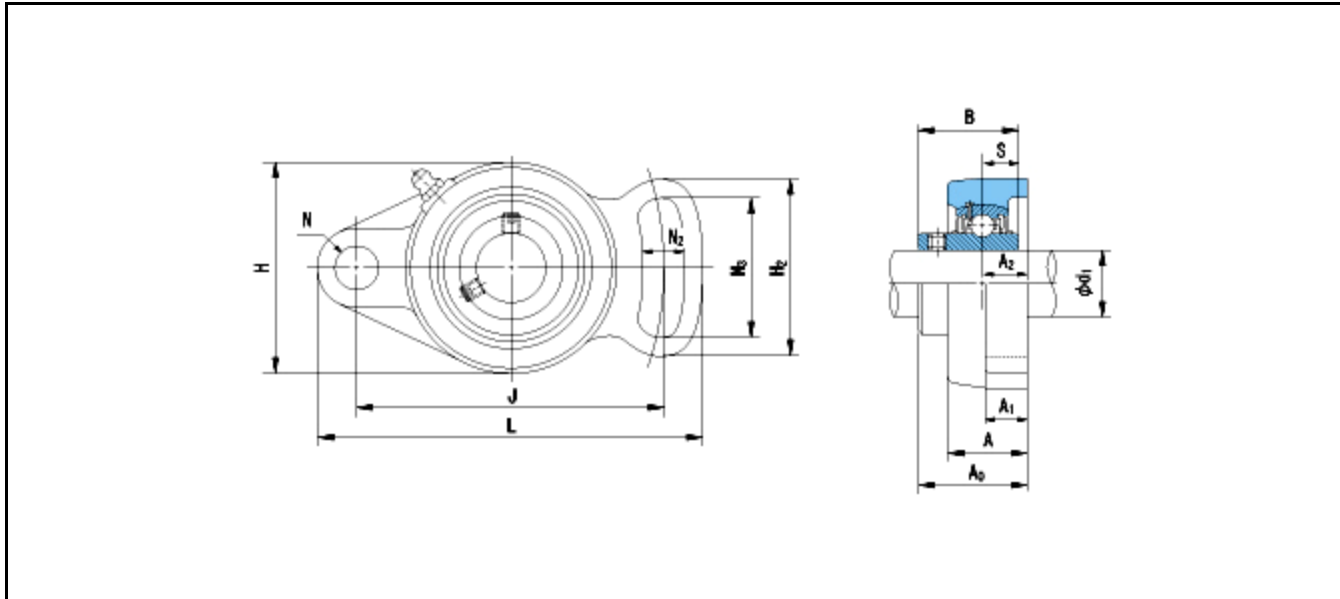

Dimensions

- d1 = 20
- A1 = 12
- A2 = 15
- A = 25.5
- A0 = 33.3
- B = 31
- S = 12.7
- Mass = 0.46 kg

<b>Basic Dynamic Load Rating Cr :</b>	<b>12800 N</b>	<b>INNER RING</b>	<b>OUTER RING</b>
<b>Basic Static Load Rating Cor :</b>	<b>6600 N</b>	<b>O.D.Surface Runout with Side :</b>	-
<b>Limiting Speed ;</b>		<b>Axial Runout with Bore :</b>	-
<b>Grease Lubrication :</b>	- rpm	<b>Axial Runout with Raceway :</b>	-
<b>Oil Lubrication :</b>	- rpm	<b>Width Variation :</b>	-
		<b>Radial Runout :</b>	-