

ROECO

Bearing Data

Ball Bearing Units

Bearing No. : **UCF319**

Dimensions

L = 290

J = 228

N = 35

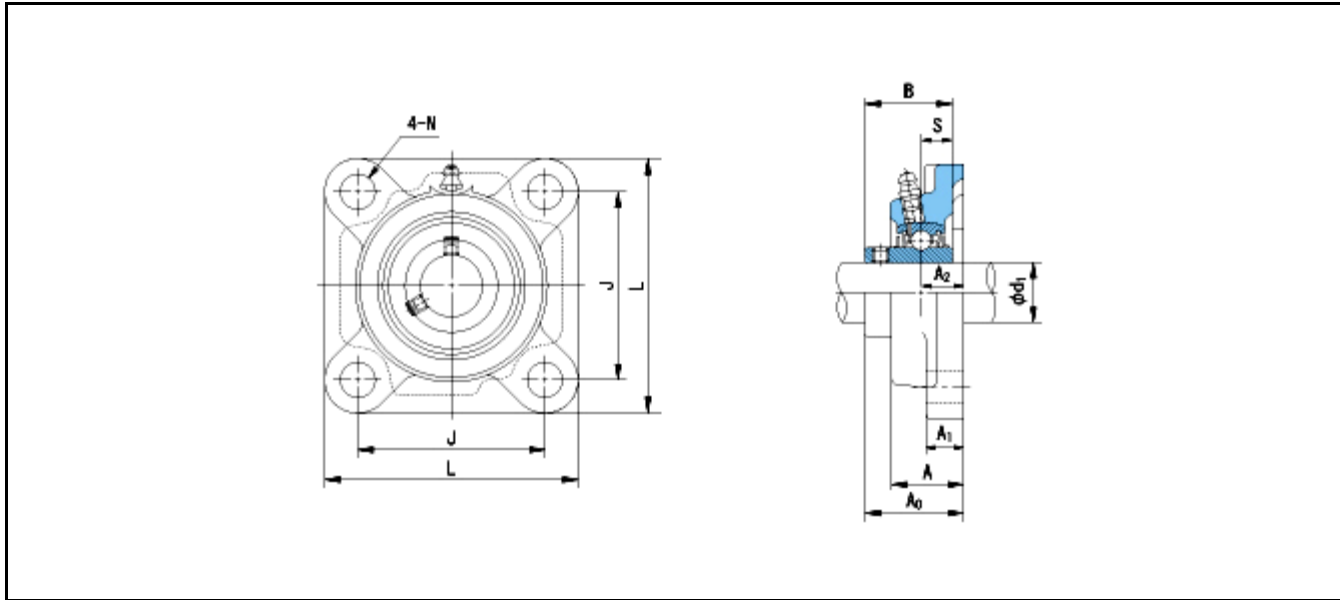

Dimensions

d1 = 95

A1 = 30

A2 = 59

B = 103

S = 41

A = 94

A0 = 121

Mass = 20.7 kg

Basic Dynamic Load Rating Cr :	153000 N				
Basic Static Load Rating Cor :	118400 N	O.D.Surface Runout with Side :			-
Limiting Speed ;		Axial Runout with Bore :			-
Grease Lubrication :	- rpm	Axial Runout with Raceway :			-
Oil Lubrication :	- rpm	Width Variation :			-
		Radial Runout :			-