

ROECO

Bearing Data

Ball Bearing Units

Bearing No. : **UCF317**

Dimensions

L = 260

J = 204

N = 31

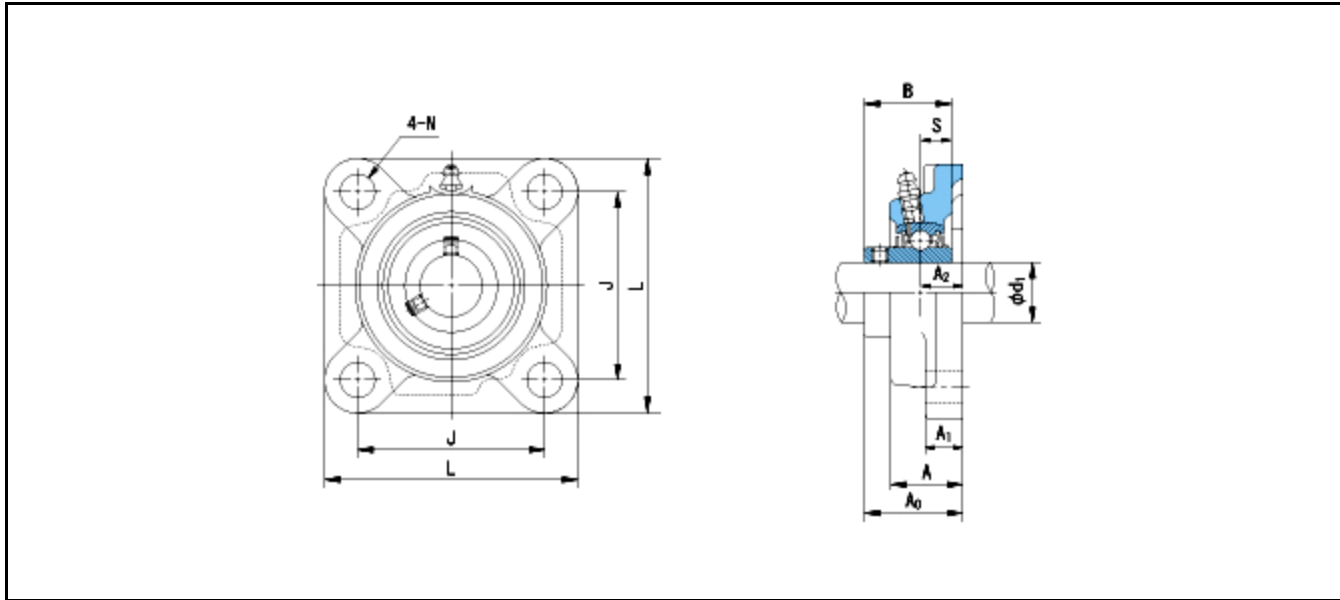

Dimensions

d1 = 85

A1 = 27

A2 = 44

B = 96

S = 40

A = 74

A0 = 100

Mass = 15.2 kg

Basic Dynamic Load Rating Cr :	132000 N				
Basic Static Load Rating Cor :	96500 N	O.D.Surface Runout with Side :			-
Limiting Speed ;		Axial Runout with Bore :			-
Grease Lubrication :	- rpm	Axial Runout with Raceway :			-
Oil Lubrication :	- rpm	Width Variation :			-
		Radial Runout :			-