

ROECO

Bearing Data

Ball Bearing Units

Bearing No. : **UCF315**

Dimensions

L = 236

J = 184

N = 25

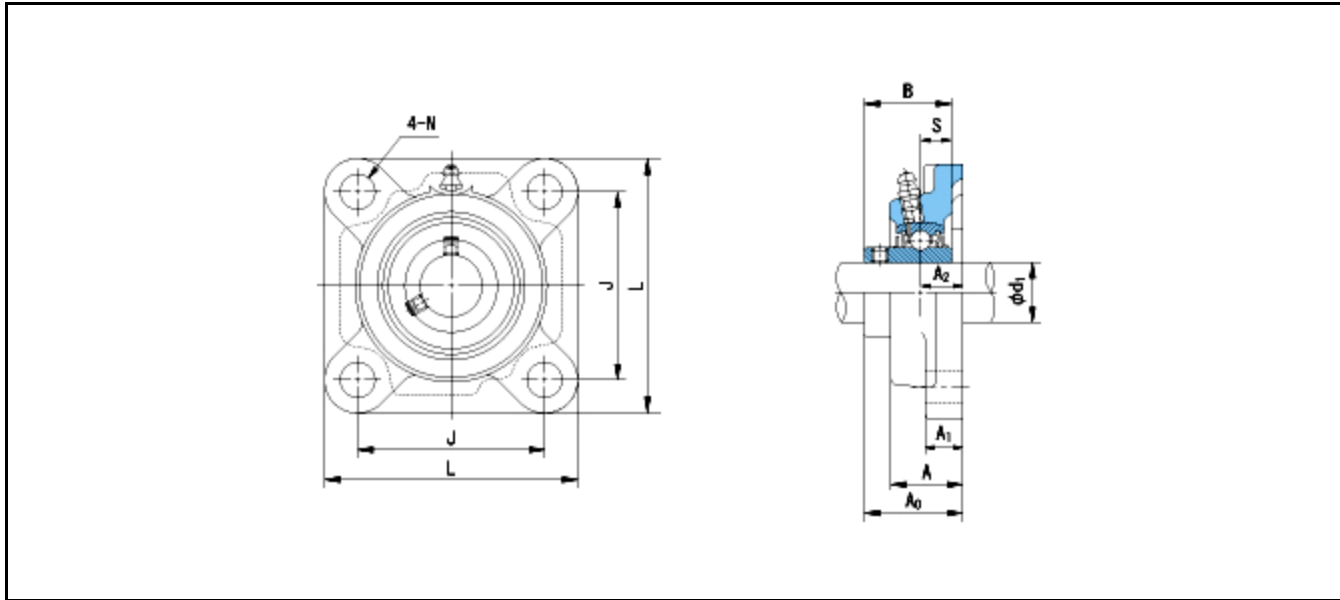

Dimensions

d1 = 75

A1 = 25

A2 = 39

B = 82

S = 32

A = 66

A0 = 89

Mass = 11.7 kg

Basic Dynamic Load Rating Cr :	114000 N				
Basic Static Load Rating Cor :	76900 N	O.D.Surface Runout with Side :			-
Limiting Speed ;		Axial Runout with Bore :			-
Grease Lubrication :	- rpm	Axial Runout with Raceway :			-
Oil Lubrication :	- rpm	Width Variation :			-
		Radial Runout :			-