

ROECO

Bearing Data

Ball Bearing Units

Bearing No. : **UCF314**

Dimensions

L = 226

J = 178

N = 25

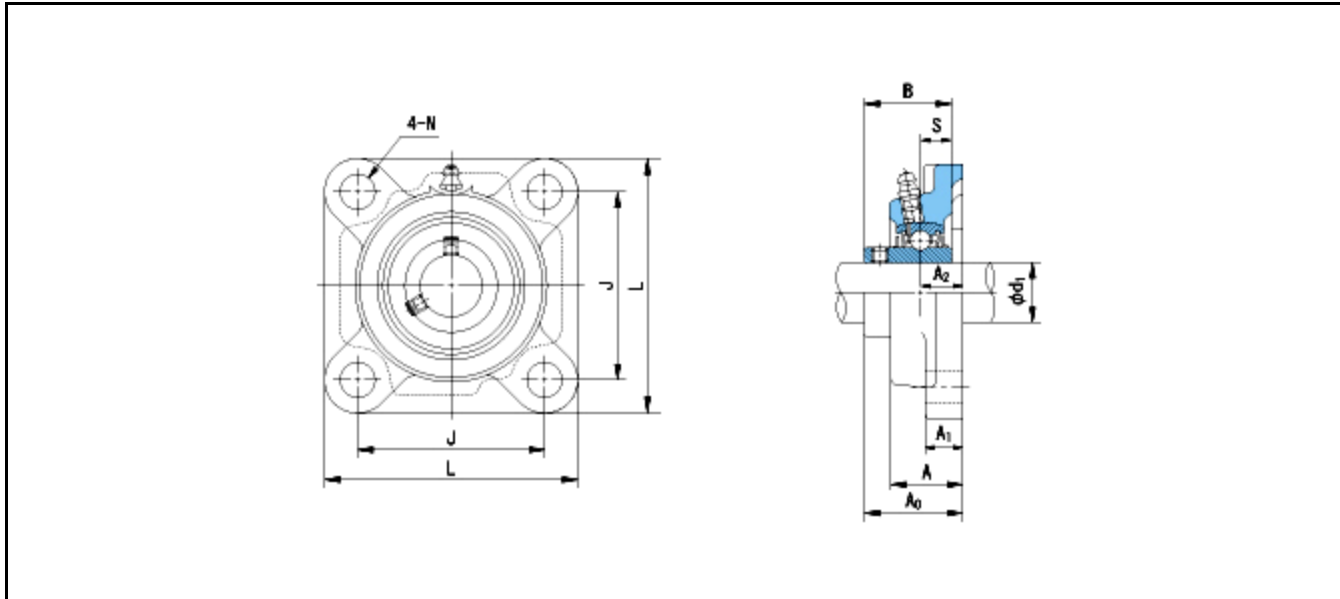

Dimensions

d1 = 70

A1 = 25

A2 = 36

B = 78

S = 33

A = 61

A0 = 81

Mass = 9.6 kg

Basic Dynamic Load Rating Cr :	104000 N				
Basic Static Load Rating Cor :	68000 N	O.D.Surface Runout with Side :			-
Limiting Speed ;		Axial Runout with Bore :			-
Grease Lubrication :	- rpm	Axial Runout with Raceway :			-
Oil Lubrication :	- rpm	Width Variation :			-
		Radial Runout :			-