

ROECO

Bearing Data

Ball Bearing Units

Bearing No. : **UCF309**

Dimensions

L = 160

J = 125

N = 19

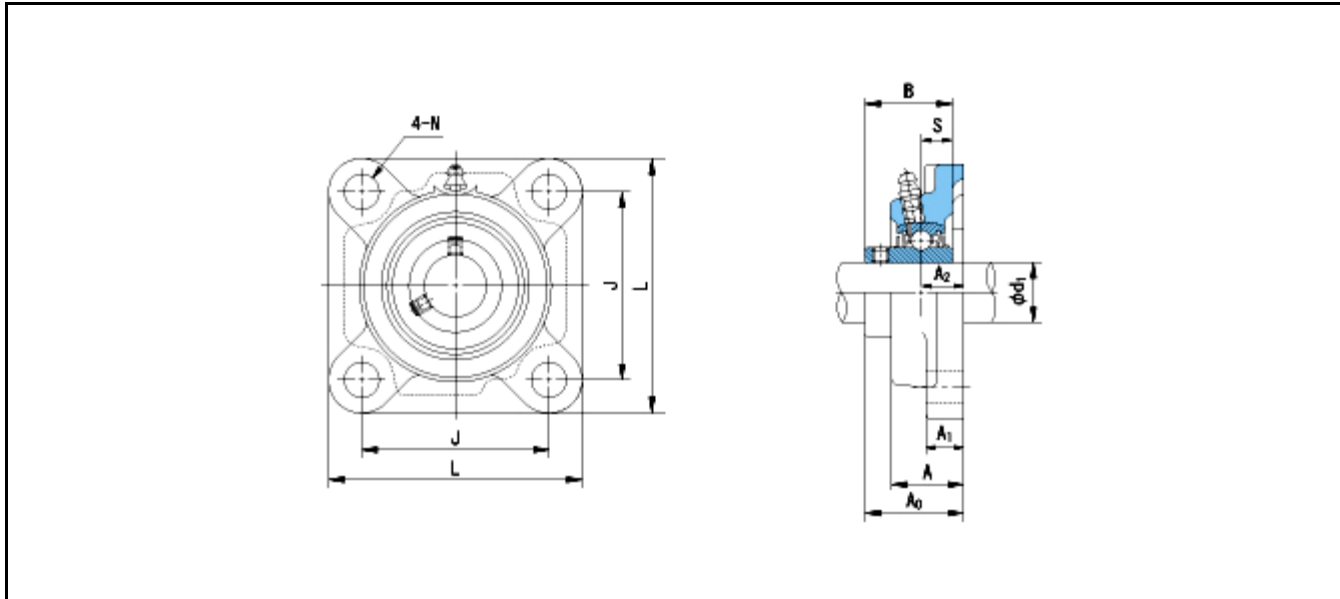

Dimensions

d1 = 45

A1 = 18

A2 = 25

B = 57

S = 22

A = 44

A0 = 60

Mass = 3.6 kg

Basic Dynamic Load Rating Cr :	51500 N				
Basic Static Load Rating Cor :	29500 N	O.D.Surface Runout with Side :			-
Limiting Speed ;		Axial Runout with Bore :			-
Grease Lubrication :	- rpm	Axial Runout with Raceway :			-
Oil Lubrication :	- rpm	Width Variation :			-
		Radial Runout :			-