

ROECO

Bearing Data

Ball Bearing Units

Bearing No. : **UCF308**

Dimensions

L = 150

J = 112

N = 19

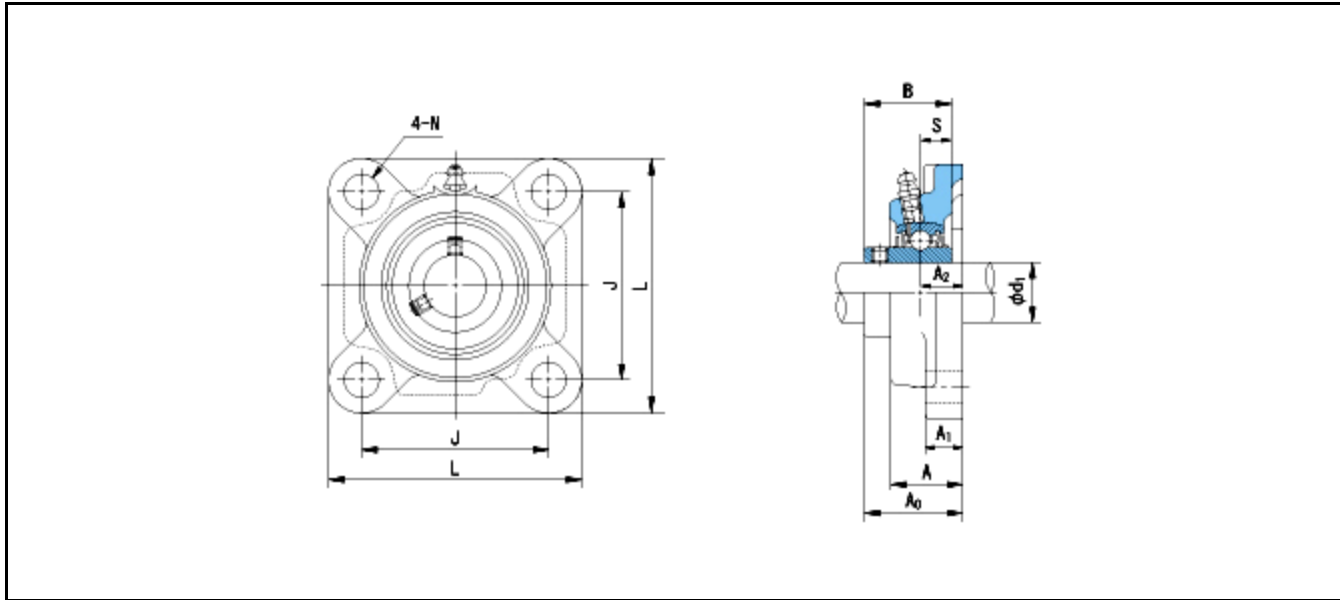

Dimensions

d1 = 40

A1 = 17

A2 = 23

B = 52

S = 19

A = 40

A0 = 56

Mass = 2.9 kg

Basic Dynamic Load Rating Cr :	40500 N				
Basic Static Load Rating Cor :	23900 N	O.D.Surface Runout with Side :			-
Limiting Speed ;		Axial Runout with Bore :			-
Grease Lubrication :	- rpm	Axial Runout with Raceway :			-
Oil Lubrication :	- rpm	Width Variation :			-
		Radial Runout :			-