

ROECO

Bearing Data

Ball Bearing Units

Bearing No. : **UCF213**

Dimensions

L = 187

J = 149

N = 19

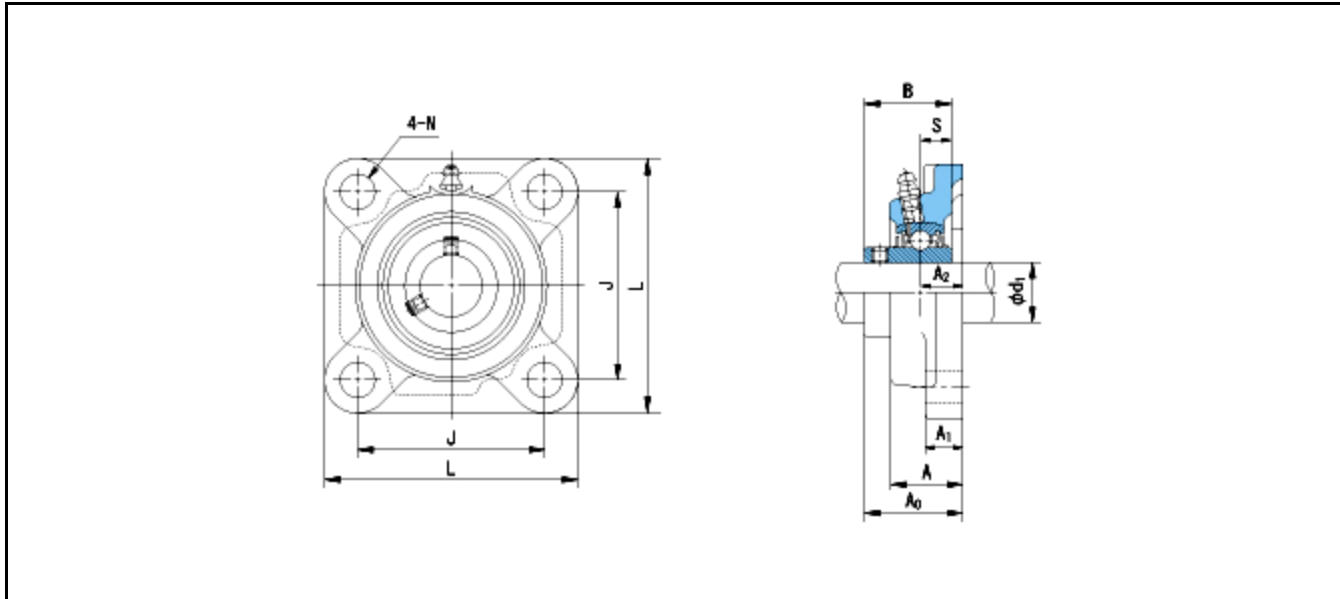

Dimensions

d1 = 65

A1 = 20

A2 = 30

B = 65.1

S = 25.4

A = 50

A0 = 69.7

Mass = 5.5 kg

Basic Dynamic Load Rating Cr :	57500 N				
Basic Static Load Rating Cor :	40000 N	O.D.Surface Runout with Side :			-
Limiting Speed ;		Axial Runout with Bore :			-
Grease Lubrication :	- rpm	Axial Runout with Raceway :			-
Oil Lubrication :	- rpm	Width Variation :			-
		Radial Runout :			-